

IBARMIA.

ZV EXTREME

60 - 58 / 55 / 50 - 48 / 45 / 40

3 AXIS MOVING COLUMN MACHINING CENTERS

For 3-axis machining operations or in combination with horizontal rotary tables:
maximum productivity by customizing the working area.



Z SERIES

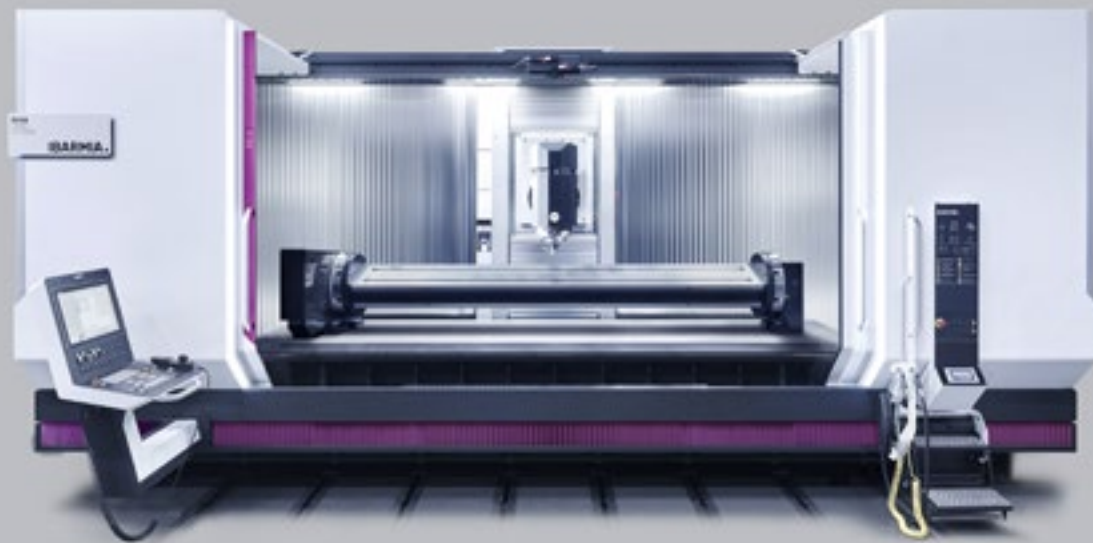

www.ibarmia.com

Z SERIES STANDARD PLATFORM



ZV SPINDLE HEAD
3 axis movement.
High dynamics spindle up to 20.000 rpm

MOVING COLUMN DESIGN

The IBARMIA moving column platform is ideal for flexible manufacturing of a wide range of pieces thanks to its heavy load capacity fixed table provided with standard side windows for extra-long parts. This 3 axis platform also allows machining complex parts in fewer setups by using A axis rotary tables as fourth axis.



MANUFACTURING TECHNOLOGY

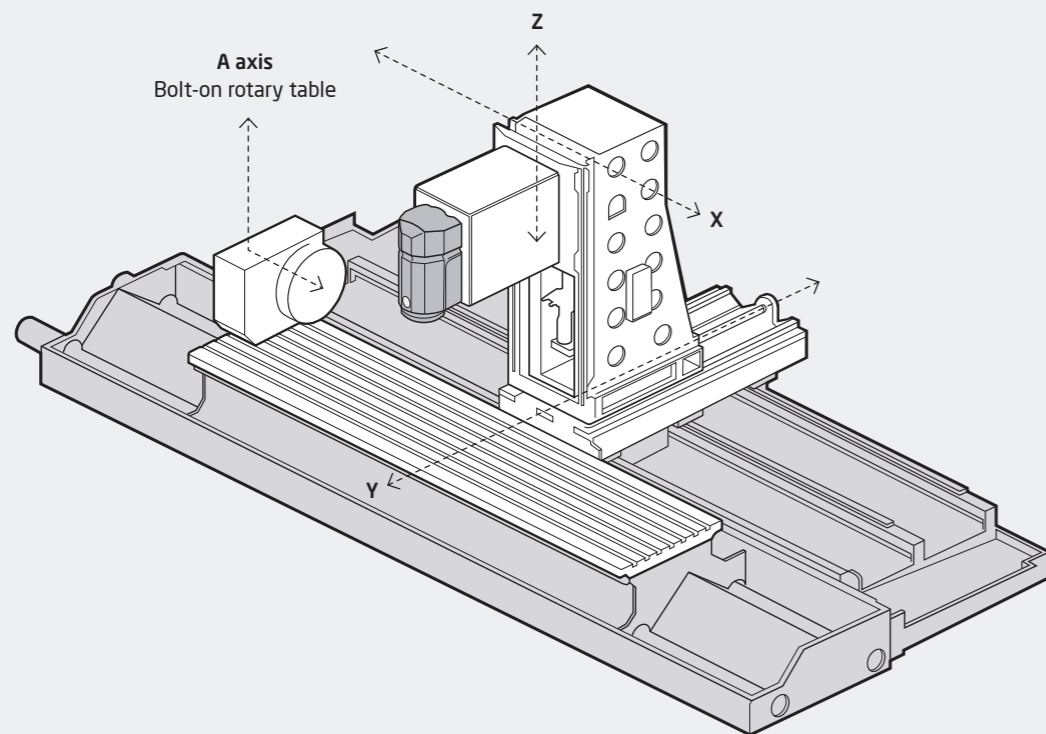

Z SERIES_ BODY SIZES FOR SK 40 & SK 50

SIZE 4_ 40 / 45 / 48 models



Y-Z travels
Y 600 / 800 / 1000 mm - Z 800 mm
Tool holder (ZV EXTREME)
SK 40 • BT 40 • HSK A-63

SIZE 5_ 50 / 55 / 58 models



Y-Z travels
Y 600 / 800 / 1000 mm - Z 1000 mm
Tool holder (ZV EXTREME)
SK 50 • BT 50 • HSK A-100

SIZE 6_ 60 model



Y-Z travels
Y 1100 mm - Z 1000 mm (Option 1200 mm)
Tool holder (ZV EXTREME)
SK 50 • BT 50 • HSK A-100

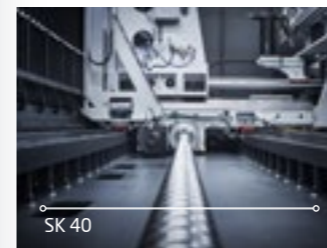

#40 Electrospindle
Power in S1 (100%); S6 (40%)
30 kW / 50 kW
Total available power from
2000 rpm
Torque in S1 (100%); S6 (40%)
130 Nm / 200 Nm
Maximal rotation speed
12.000 rpm

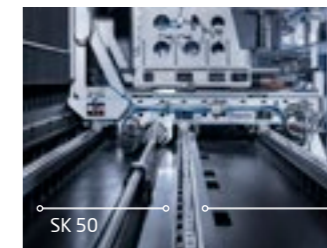

#50 Electrospindle
Power in S1 (100%); S6 (40%)
74 kW / 84 kW
Total available power from
4000 rpm
Torque in S1 (100%); S6 (40%)
300 Nm / 452 Nm
Maximal rotation speed
12.000 rpm

2 guideways structure
IBARMIA adapts the machine structure to each electrospindle type. By this way, in the #40 machines the column carriage travels over two guideways.

3 guideways structure
By the same way IBARMIA introduces a bigger three guideways structure for #50 spindles, to endure the forces applied when machining hard materials with high power.

Z SERIES_ UP TO 12.000 mm IN X AXIS

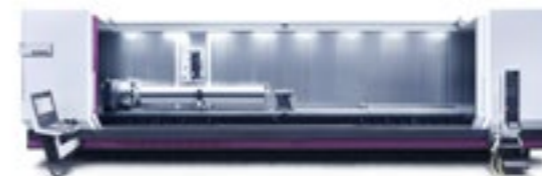

A wide range of lengths available
1600 / 2200 / 3000 / 4000 / 5000 / 6000 / 7000 / 8000 / 9000 / 10.000 / 11.000 / 12.000 mm

Z SERIES_ Y AXIS ZERO GRAVITY DESIGN

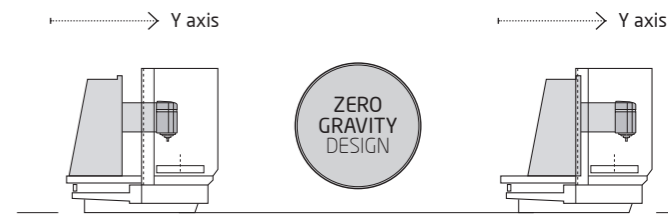

Constant cutting conditions on Y axis
Fixed distance monoblock column design: accuracy, power and rigidity on the full travel of the Y axis.

ZV EXTREME_ MACHINE IT ALL

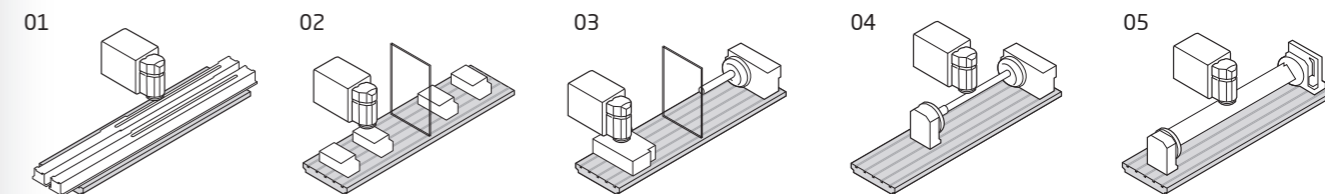

Create your own machine
The high configurability and the combination of axes provide a wide field of work which ensures an efficient return on the investment.

- 01_
 - Thermo-symmetrical and thermostable structure design.
- 02_
 - Maximum stability in the monoblock design of the machine bed. Structural bodies of maximum rigidity for an optimum performance throughout the machine's life cycle.
- 03_
 - Rectified ball screws of high precision with preloaded double nuts for the longitudinal axis movement in machines up to 6000 mm long.
 - Machines from 3000 mm long are provided with ball screw supports to prevent bending and vibrations in rapid movements.
- 04_
 - Rack and pinion system on the longitudinal axis in machines from 7000 mm long.
 - Movement on X / Y / Z axes over linear guides with preloaded rolling shoes with two rows of circulating rollers.
- Standard measuring device on X, Y, Z axes in our machining centres: glass scales.
- 04_
 - Geometric check and volumetric calibration of the machine by laser interferometer on request, according to ISO 230- 2, -4 and -6.

Z SERIES_ CONSTRUCTION FEATURES



Z SERIES_ STANDARD CHARACTERISTICS

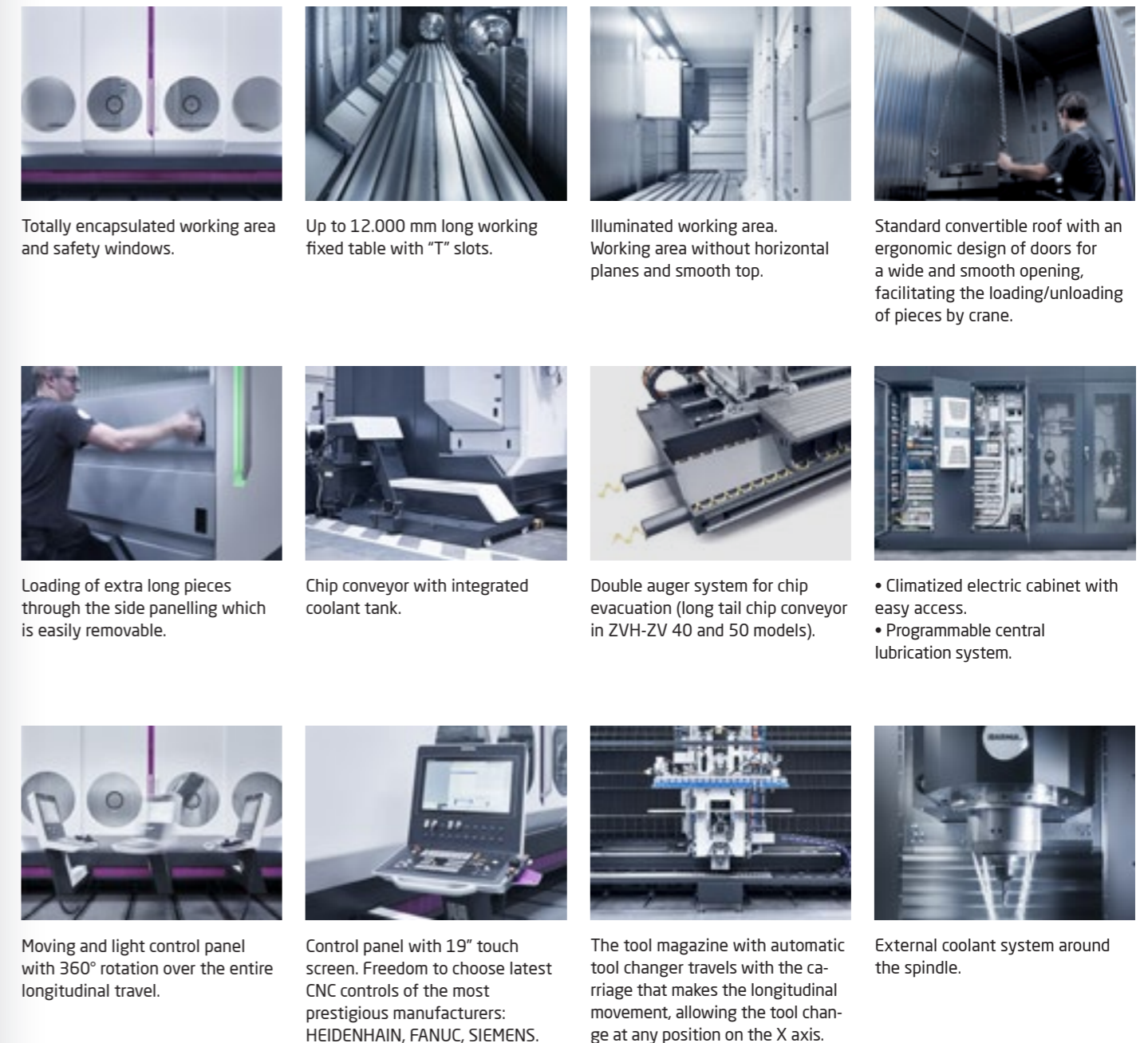

Subject to change without prior motive. Informative contents are not binding.



MOVING COLUMN MACHINING CENTERS

ZV MODELS_ MAIN CONFIGURATION OPTIONS



Fixed table combined with high dynamics spindles; an efficient working area for quick change over a wide type of parts.



Non stop machining option that includes a central division wall, independent blocking of front doors, and pendulum cycle work area management software.



Bolt-on rotary tables to be used in horizontal axis for 4 axis complex parts machining.

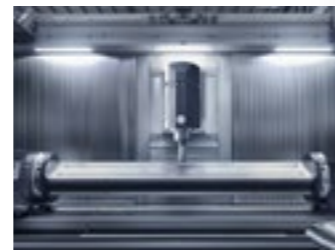

Trunnion fixtures over the fixed table using bolt-on rotary tables and supporting plates.



Customized working areas: Mixed solution: Plate fixed between A axis rotary table and supporting plate in one side; standard fixed table in the other side.

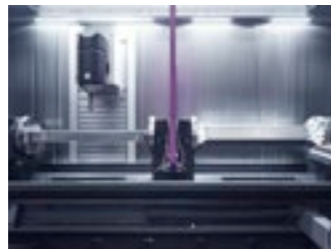

Customized working areas: Trunnion fixtures avoiding the standard fixed table, facilitating the direct fall of chips to the evacuation area.

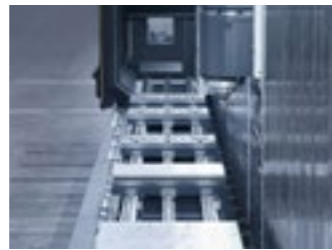

Customized working areas: sliding platforms on guideways replacing the fixed table, that can be quickly re-positioned for machining parts with different lengths.

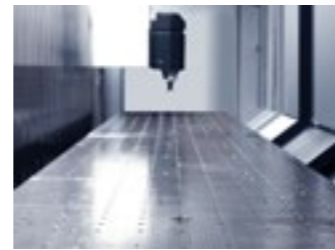

Clamping systems Special fixed tables with vacuum clamping system for aluminium long parts.

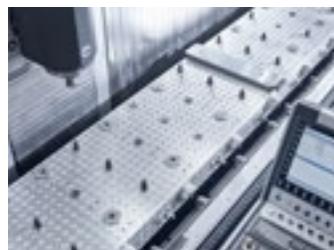

Clamping systems Special fixed tables with ZERO points for a quick clamping of pieces, managed by pneumatic or hydraulic connections.



Pick up stations integrated in the machine to hold special tools, angular heads etc.



Specific solutions for customers that need to manage a high number of tools: fixed magazines, rack type configurations etc.

Another optional items

- Coolant through spindle.
- Tool measuring and touch systems.
- Steam and mist aspiration system.
- Air and water guns.
- "Comfort" pack: Sliding access stairway along the longitudinal travel with supports for air and water guns.
- "Illumination" pack: LED lights with acoustic signal indicating the state of the machine, integrated into the sides.
- Lights with acoustic signal indicating the machine status.
- Camera settings and display mode.
- Control with touch screen up to 24".



MANUFACTURING TECHNOLOGY

ZV EXTREME_ MACHINE CONFIGURATION EXAMPLES

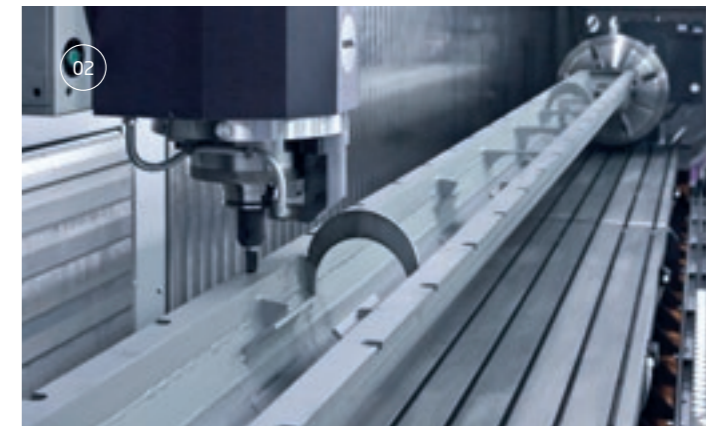

IBARMIA ECO DESIGN



Machines designed considering the environmental impact during all their useful life cycle.

01_ Trunnion fixture over double motor system, that allows machining 4 faces in one set up.
02_ 4 axis machining of long parts by using bolt-on rotary tables.

03-04_ The fixed table is ideal for those industries that often require working on extremely long pieces, for which IBARMIA offers different clamping solutions and special tools.

ZV EXTREME

MAXIMUM FLEXIBILITY IN 3 AXIS MACHINING CENTERS

Combine high dynamics electro-spindle heads with all the advantages that IBARMIA's awarded moving column structure offers. (See below)

1_ Multiply the working table capacity by using up to 4 faces trunnion fixtures over A axis rotary tables. **2_** Use bolt-on rotary tables for up to 4 axis machining of complex parts.

3_ Use the fixed table for works over a wide range of parts even beyond the machine X travel, thanks to the side easy removable panneling for extra long pieces.

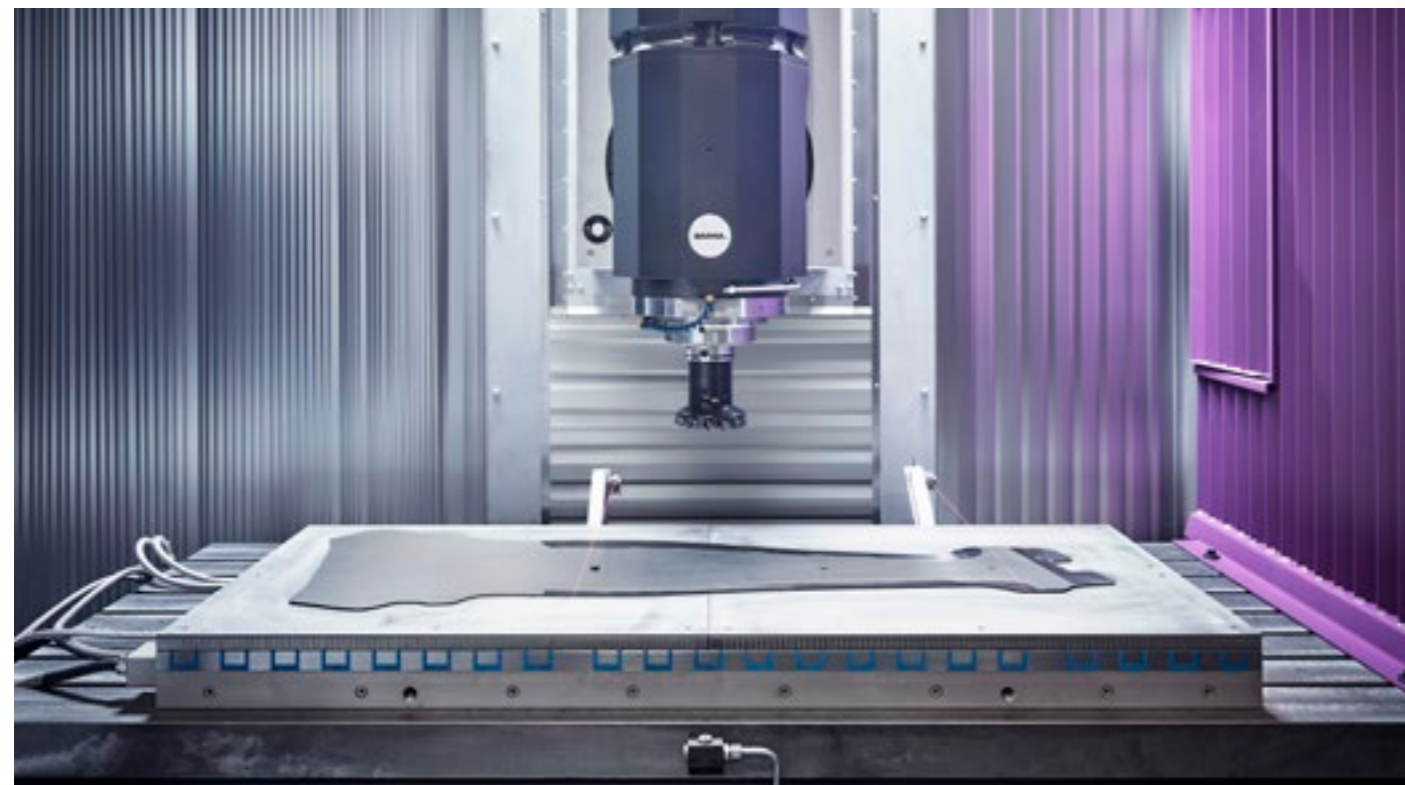
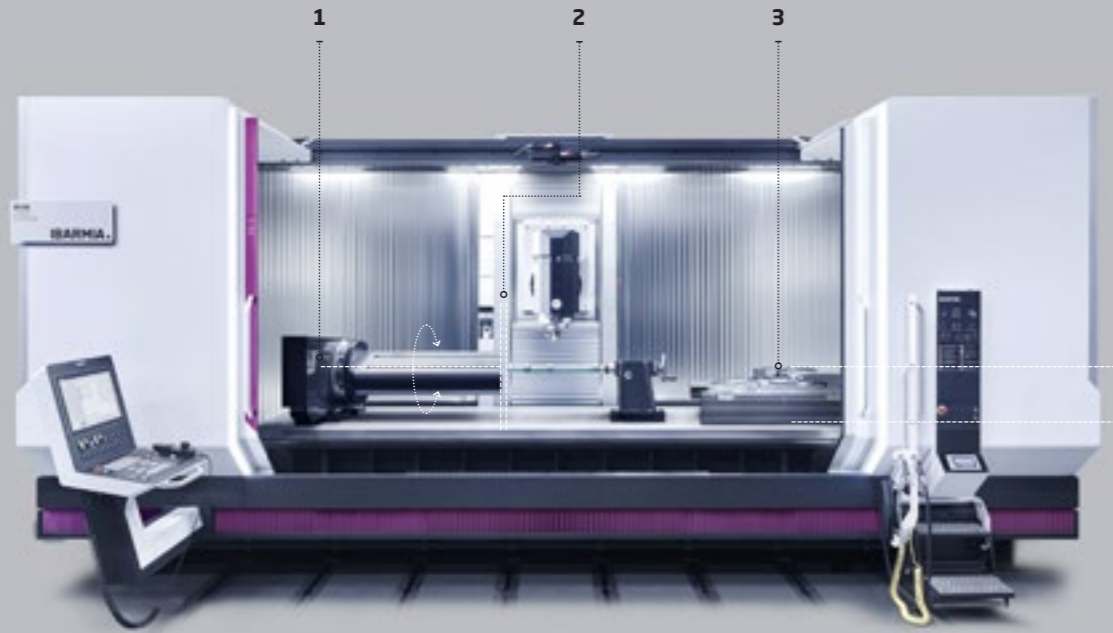

ZV EXTREME



MOVING COLUMN MACHINING CENTERS

ZV EXTREME_ SAMPLE APPLICATIONS



Industrial blade

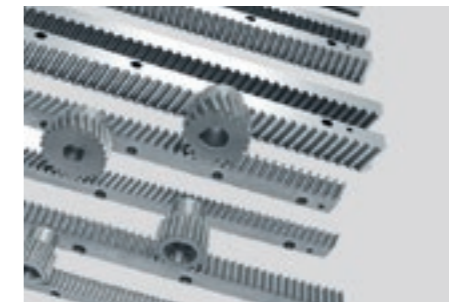

Industrial rack

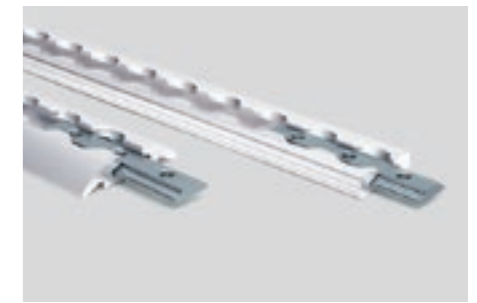

Clamping rail

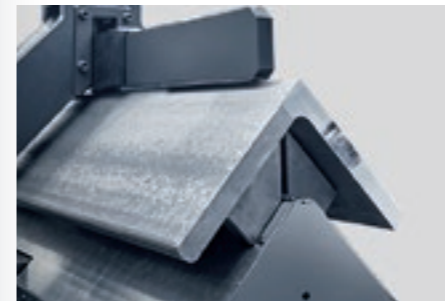

Structural angular profile



Machinery component



Knife gate valve body



Aircraft structural part



Main engine motor mount block girde

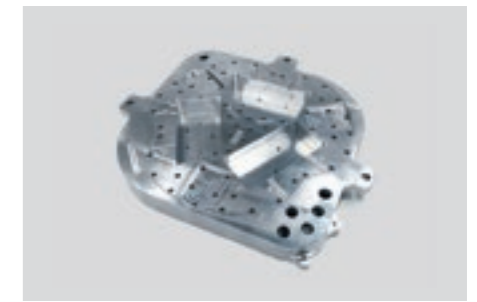

Industrial mold



MACHINERY



RAILWAY



LIFTING DEVICES



VALVES & PUMPS



AEROSPACE



AUTOMOTIVE



MOLD & DIE

Z SERIES
LARGE SELECTION
OF ELECTROSPINDLES*

SK 50 BODY SIZES

1_ STANDARD

Power and dynamics_
Up to 12.000 rpm.
74/84 kW (S1/S6).
300/452 Nm (S1/S6)

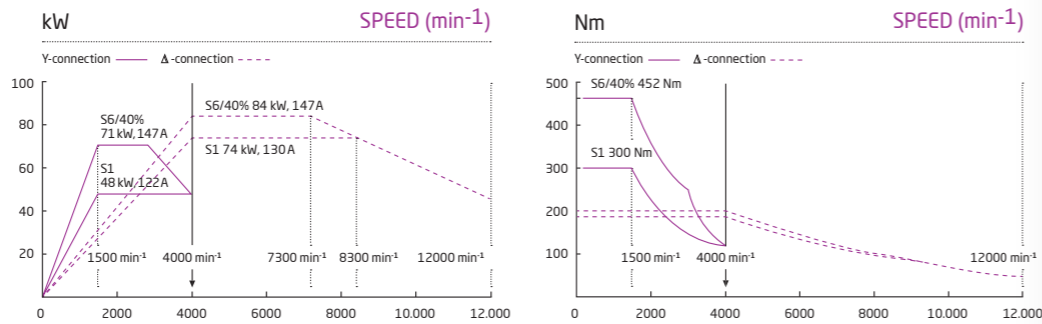

2_ OPTIONAL

High torque for the hardest materials_
Up to 7000 rpm.
52/73 kW (S1/S6).
500/700 Nm (S1/S6)

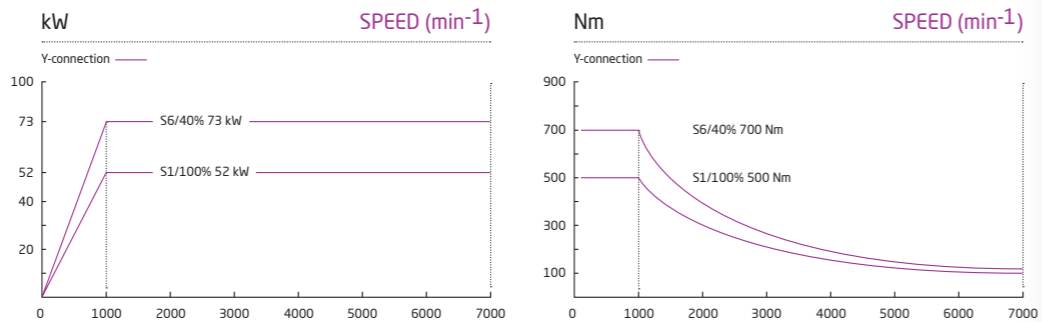

SK 40 BODY SIZES

1_ STANDARD

Dynamics and high revolutions_
Up to 12.000 rpm.
(Option 15.000 rpm)
30/50 kW (S1/S6).
130/200 Nm (S1/S6)

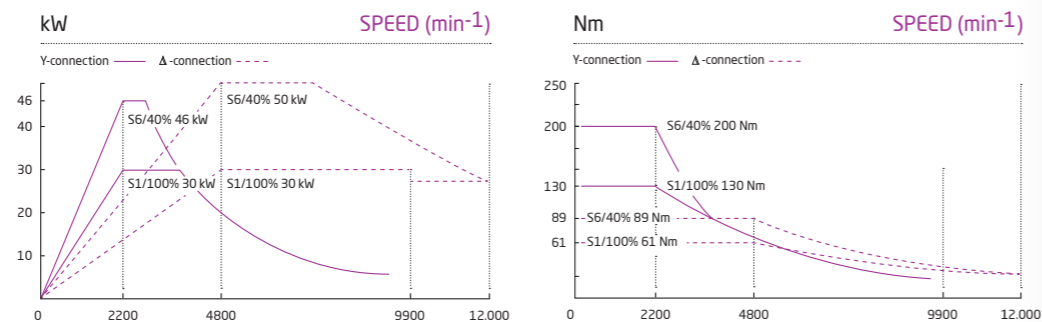

2_ OPTIONAL

Higher speed and dynamics_
Up to 20.000 rpm.
25/40 kW (S1/S6).
87/135 Nm (S1/S6)

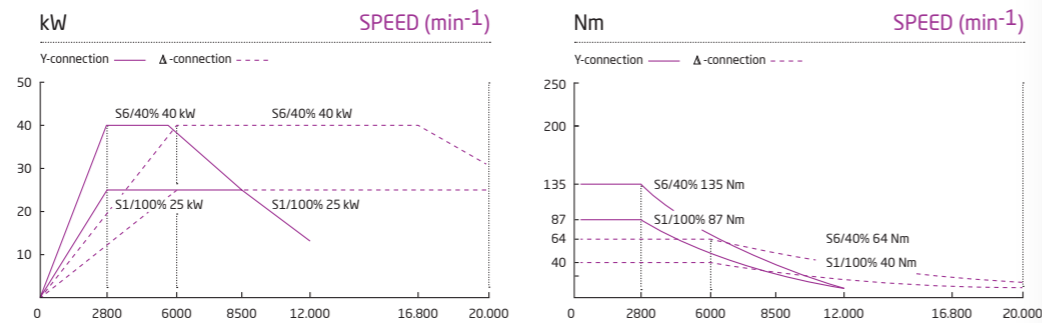

*More spindles on request

ZV EXTREME
TECHNICAL DATA

STROKES

- X axis travel (length)
- Y axis travel (cross)
- Z axis travel (vertical) (*optional)
- Piece maximum height
- Distance spindle nose-table.

WORKING AREA

- Fixed table dimensions
- Maximum table load capacity
- Number of "T" slots
- "T" slots size
- Distance between "T" slots
- Fixed table height

MAIN SPINDLE

- Tool holder
- Maximum speed
- Maximum power
- Maximum torque (Nm)

FEED

- Feed thrust X-Y-Z 100%
- Rapid feed for positioning X-Y-Z
- Maximum working feed X-Y-Z

ACCURACY VDI / DGQ3441

- Positioning Tp X-Y-Z (1000 mm)
- Repeatability

CAPACITIES

- Milling capacity in steel St 60
- Drilling capacity in steel St 60
- Tapping capacity in steel St 60

TOOL MAGAZINE

- Number of tools
- Maximum tool length
- Maximum tool weight
- Maximum tool diameter with full magazine
- Maximum tool diameter with free spaces
- Tool changing time
- Chip to chip time

CNC CONTROL

- Available digital controls

SK 50 BODY SIZES				SK 40 BODY SIZES		
ZV 60	ZV 58	ZV 55	ZV 50	ZV 48	ZV 45	ZV 40
-X axis travel (length)						
1600 - 12.000 mm						
-Y axis travel (cross)						
1100 mm	1000 mm	800 mm	600 mm	1000 mm	800 mm	600 mm
-Z axis travel (vertical) (*optional)						
1000 mm (1200*)				1000 mm		800 mm
-Piece maximum height						
1100 mm				900 mm		
-Distance spindle nose-table.						
0---1100 mm				0---900 mm		
-Fixed table dimensions						
L1600-2200: X +400 mm; ≥ L3000: X+600 mm & Y +50 mm						
-Maximum table load capacity						
2000 Kg/m²				1500 Kg/m²		
-Number of "T" slots						
9	7	5		7		5
-"T" slots size						
18 H7 mm						
-Distance between "T" slots						
125 mm						
-Fixed table height						
1075 mm				1050 mm		
Standard: SK 50 - Option: BT 50 / HSK A-100						
Standard: SK 40 - Option: BT 40 / HSK A-63						
Standard: 12.000 rpm - Option: 7000 rpm						
Standard: 12.000 rpm - Option: 20.000 rpm						
Standard: 84 kW - Option: 75 kW						
Standard: 50 kW - Option: 40 kW						
Standard: 452 Nm - Option: 700 Nm						
Standard: 200 Nm - Option: 135 Nm						
X: 15.021 N / Y: 12.154 N / Z: 10.649 N						
X: 11.992 N / Y: 8521 N / Z: 7669 N						
45 m/min						
45-48-48 m/min						
30 m/min						
10 µm						
5 µm						
1100 cm³/min						
900 cm³/min						
ø 70 mm						
ø 50 mm						
M 45 mm						
M 33 mm						
30. Optional: 40, 60, 80 and more available on request.						
24. Optional: 40, 60, 80 and more available on request.						
400 mm						
350 mm						
20 kg						
10 kg						
ø 125 mm (ø 100 mm with 60-80 ATC)						
ø 90 mm (ø 80 mm with 60-80 ATC)						
200 mm						
150 mm						
10 s						
8 s						
12 s						
Fanuc / Heidenhain / Siemens						

Subject to change without prior motive. Informative contents are not binding.

IBARMIA.



YOUR MACHINE TOOL POINT

Diego Umantsoro, 5 - Apdo 35
20720 Azkoitia (Gipuzkoa) Spain. T +34 943 857 000
ibarmia@ibarmia.com

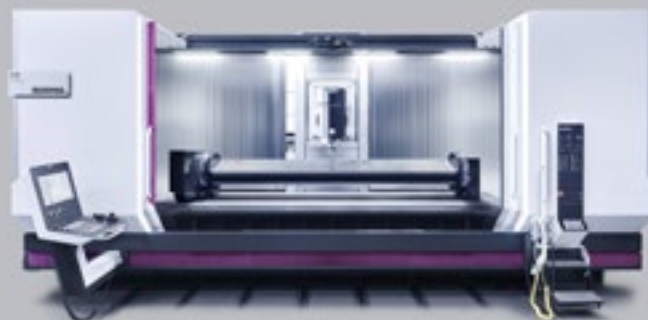

www.ibarmia.com