

T SERIES

5 AXIS UNIVERSAL MACHINING CENTERS

IBARMIA.
YOUR MACHINE TOOL POINT

T12 / T16 / T22 / T30 / T36 MODELS

Universal machining centers for 5 axis machining of big diameter parts, focused on high productivity by integrating multitasking technology and automation systems.



T SERIES

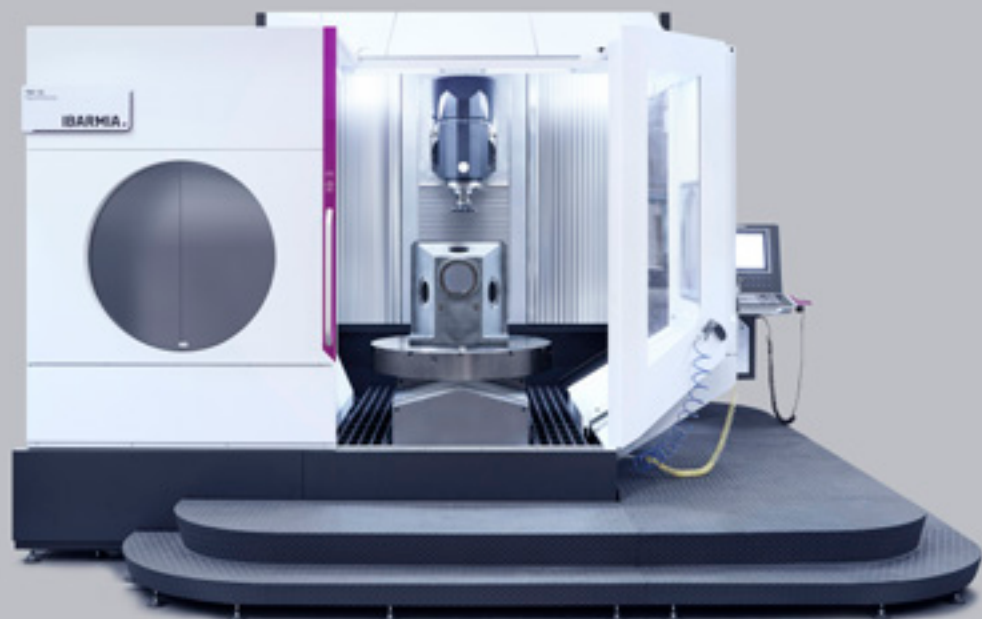

www.ibarmia.com



T SERIES

YOUR MACHINE TOOL POINT

IBARMIA.

INTRO

Technology and Innovation. For those customers looking for big swing diameters or aiming to machine in a single set up, IBARMIA presents the T Series models, whose serial name refers to the bed shape and the configuration of X / Y axes, in combination with different head types and rotary tables. The entire range of machines is available with single table or multiple table solutions, and in MULTIPROCESS version (multitasking center) or in EXTREME version (milling center) increasing the versatility and flexibility of the machine.

- 1_ General view
- 2_ Application industries
- 3_ Advantages
- 4_ Characteristics
- 5_ Machine Configuration
- 6_ The range
- 7_ Technological integration
- 8_ Technical data



T SERIES

1_ GENERAL VIEW

HIGH PRODUCTIVITY MACHINES

The T SERIES is designed for high productivity of heavy pieces thanks to its high load capacity rotary tables and powerful spindles. Its award-winning tilting heads provide the speed, accuracy and reliability required for the most complex jobs. The most advanced automation solutions for automatic pallet

changing and special head changing operations, make the T SERIES the ideal solution for the most demanding production requirements. The MULTIPROCESS models integrate milling, turning and grinding capacity, reducing the number of machines required to produce a wide range of pieces.

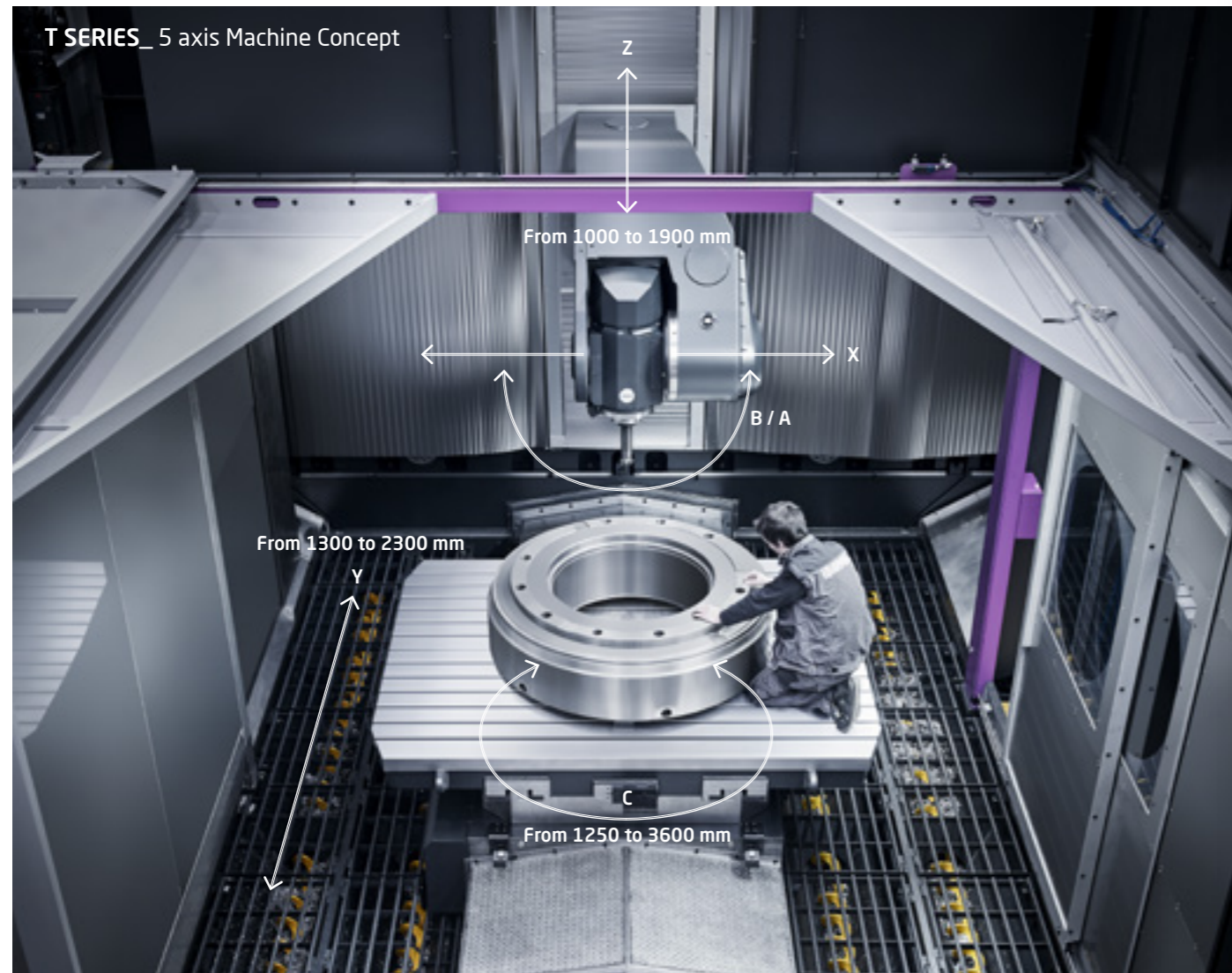

MACHINE SIZES

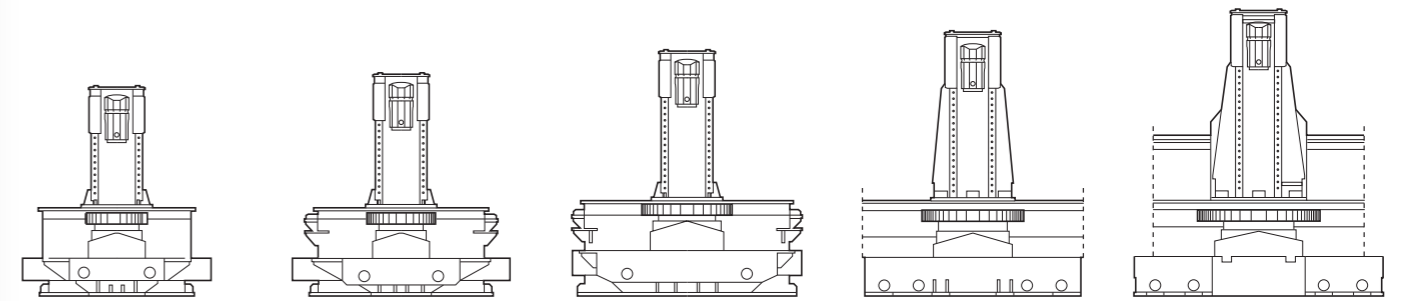

Maximum swing diameter
ø 1250 mm
Maximum part height
h 1600 mm
Maximum load capacity
4500 Kg



Maximum swing diameter
ø 1600 mm
Maximum part height
h 1700 mm
Maximum load capacity
6000 Kg



Maximum swing diameter
ø 2200 mm
Maximum part height
h 1750 mm
Maximum load capacity
10.000 Kg



Maximum swing diameter
ø 3000 mm
Maximum part height
h 1950 mm
Maximum load capacity
20.000 Kg



Maximum swing diameter
ø 3600 mm
Maximum part height
h 2150 mm
Maximum load capacity
25.000 Kg

SPINDLE HEADS



THC_ B axis head
Maintain the same tool center point across the full range
-15°/+195°



THR_ A axis head
Fork type spindle head ideal for negative angles
-45°/+135°



High torque & high speed
Latest technology electrospindles

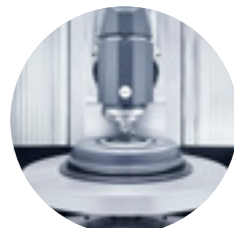

Direct Drive Technology
Torque motor transmission working tables



PERFORMANCE LEVELS



T MULTIPROCESS
Universal machining centers for 5-axis vertical milling and turning operations.
Housing: HSK A-100 / Capto C8



T EXTREME
Universal machining centers for 5-axis / 5-sided milling operations.
Housing: SK 50 / BT 50 / HSK A-100

- [1_ General view](#)
- [2_ Application industries](#)
- [3_ Advantages](#)
- [4_ Characteristics](#)
- [5_ Machine Configuration](#)
- [6_ The range](#)
- [7_ Technological integration](#)
- [8_ Technical data](#)

2_ APPLICATION INDUSTRIES

5 AXIS ADVANCED MACHINING

The T SERIES is the ideal solution for high production of medium and large size cubic pieces in a single set up, with power and accuracy. A generous workspace and the combination of linear and rotary axes, offer a wide range of solutions for advanced machining in 5 axes / 5 faces on parts up to $\varnothing 3600$ mm and h2150 mm in a wide range materials and the most complex geometries.

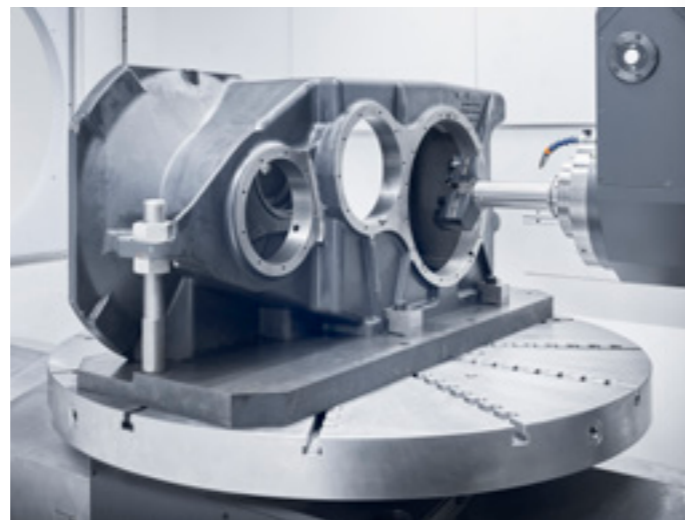

RANGE OF MACHINING

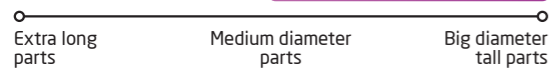

MULTI
PROCESS
TECHNOLOGY

5
AXIS

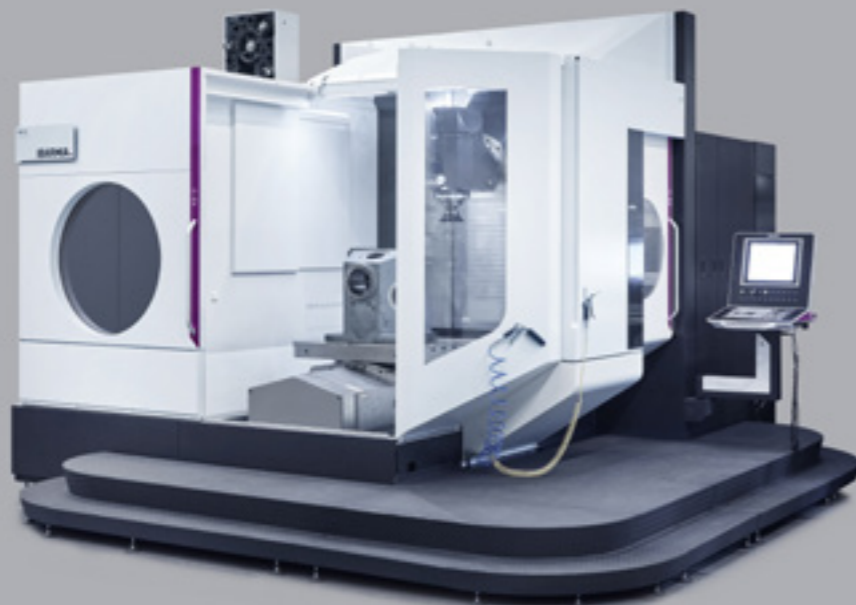

T SERIES

SAMPLE APPLICATIONS



Fluid end



Industrial mold



Compressor Cylinder



Turbocharger housing



Valve body



Engine block



Roller cage for bearings

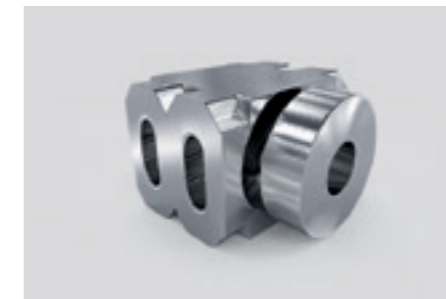

Ram Bop



Aerospace engine housing

INDUSTRIES & MATERIALS



OIL & GAS



MOLD & DIE



AEROSPACE



AUTOMOTIVE



RAILWAY



MACHINERY



YELLOW GOODS

Low-Alloy Steel | Grey Cast Iron | Nickel based Super Alloy | Austenitic Stainless Steel | Aluminium based Alloy | Extra hard Steel

- [1_ General view](#)
- [2_ Application industries](#)
- [3_ Advantages](#)
- [3.1_ Increase machine travels](#)
- [4_ Characteristics](#)
- [5_ Machine Configuration](#)
- [6_ The range](#)
- [7_ Technological integration](#)
- [8_ Technical data](#)

CREATE YOUR OWN MACHINE WITH THE IBARMIA T SERIES; AN UNRIVALLED PROPOSAL IN TERMS OF MACHINE CONFIGURATION POSSIBILITIES

3.1_ ADVANTAGES / MACHINE CUSTOMIZING

INCREASE MACHINE TRAVELS

The T SERIES offers a balanced range of construction sizes, designed to meet the needs of advanced m ng on a wide range of part sizes. However, given IBARMIA's customer orientation and the varied market requirements, the programme also offers a higher flexibility with the possibility of increasing both the vertical and transversal travels as well as the overhanging of the spindle neck.

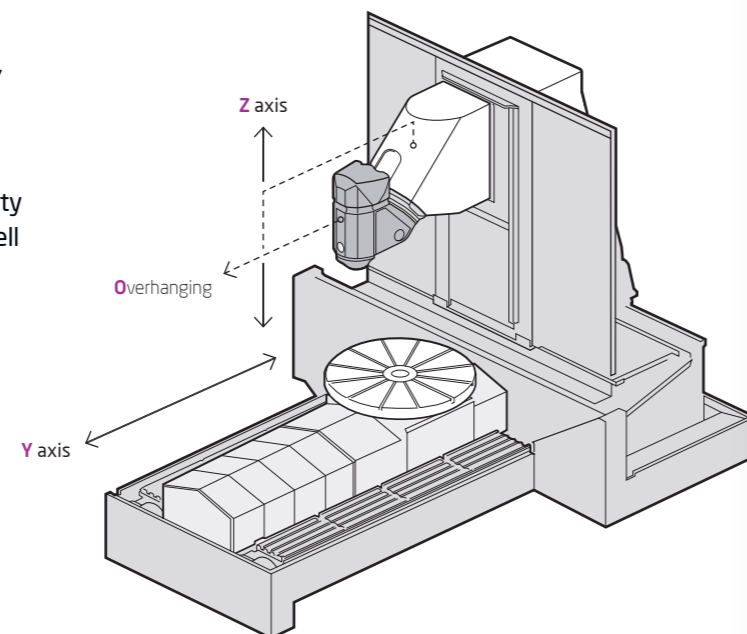

"ADAPT MACHINE TRAVELS TO YOUR PRODUCTION REQUIREMENTS, MAINTAINING THE SAME ACCURACY, RIGIDITY AND DURABILITY"*

TRAVEL INCREASES BY MACHINE SIZES

T12

Parts up to
h 1600 mm / 4.500 Kg
Linear axes (mm)
X 1200 Y 1300 Z 1000
Axis can be increased
Z +200
Overhanging (mm)
Can be increased up to
125 mm

T16

Parts up to
h 1700 mm / 6.000 Kg
Linear axes (mm)
X 1600 Y 1600 Z 1200
Axis can be increased
Z +300
Overhanging (mm)
Can be increased up to
125 mm

T22

Parts up to
h 1750 mm / 10.000 Kg
Linear axes (mm)
X 2200 Y 1600 Z 1500
Axes can be increased
Y +150 / 300 Z +200
Overhanging (mm)
Can be increased up to
150 mm

T30

Parts up to
h 1950 mm / 20.000 Kg
Linear axes (mm)
X 3000 Y 2000 Z 1700
Axes can be increased
Y +150 / 300 Z +200
Overhanging (mm)
Can be increased up to
100 mm

T36

Parts up to
h 2150 mm / 25.000 Kg
Linear axes (mm)
X 3600 Y 2300 Z 1900



SAME SWING, INCREASED VERTICAL TRAVEL

The possibility of increasing the vertical travel while maintaining the same swing diameter means that the whole assembly does not have to be oversized to obtain this gain, which is particularly advantageous for those companies who only require more vertical travel and do not need to opt for a larger model.

- [1_ General view](#)
- [2_ Application industries](#)
- [3_ Advantages](#)
- [3.2_ Extensive tool management](#)
- [4_ Characteristics](#)
- [5_ Machine Configuration](#)
- [6_ The range](#)
- [7_ Technological integration](#)
- [8_ Technical data](#)



3.2_ ADVANTAGES / MACHINE CUSTOMIZING

MULTIPLE SOLUTIONS FOR TOOLS AND SPECIAL HEADS MANAGEMENT

The T SERIES offers a wide range of flexible and modular solutions in the field of tool management and tool storage. From modular chain magazines to compact solutions such as polar magazines for standard tools, or the management of long tools and/or special heads managed by a robot arm, the T SERIES offers a wide range of flexible and modular solutions in the field of tool management and storage by robot arm.



Tailored to our customers

We offer intelligent tool management options such as tool reading on the tool, reducing set-up times and errors due to manual data input, as well as various devices for monitoring tool breakage and wear by means of probing, laser beam or spindle consumption measurement.

TOOL MANAGEMENT SOLUTIONS DESIGNED AND CUSTOMISED ACCORDING TO THE NEEDS OF OUR CUSTOMERS

The tool management unit is located outside the working area, separated from the main structure of the machine so that its movements are not transmitted to the machine, allowing a wide range of solutions:

- 1_ Servo-driven vertical chain magazines of 120-240-360 positions. Tool changes up to 7" (chip to chip) for tools up to 600 mm and 30 kg.
- 2_ Integrated pick ups, associated with double holder changeover for long and/or heavy tools.

3_ Compact solution in polar magazines with configurations for 134 and 255 tools.

4_ Loading stations located on the outside of the area for manual supply of tools to the magazine without interruptions.

5_ Polar magazines with up to 400 positions, managed by double holder robot arm, combining tool and special heads change. Configurations according to the weight of tools and heads: up to 40 Kg or up to 100 Kg.

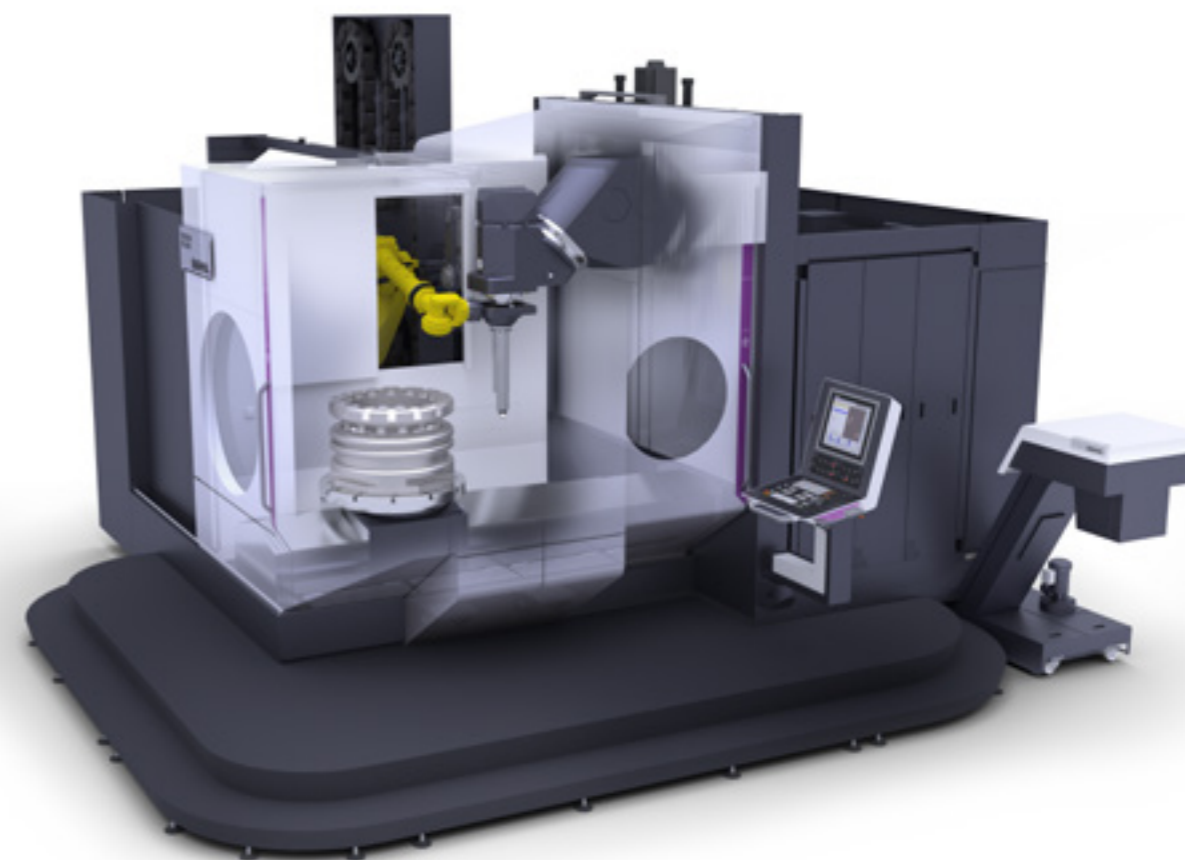

- [1_ General view](#)
- [2_ Application industries](#)
- [3_ Advantages](#)
- [4_ Characteristics](#)
- [4.1_ Dynamics, Power & Accuracy](#)
- [5_ Machine Configuration](#)
- [6_ The range](#)
- [7_ Technological integration](#)
- [8_ Technical data](#)

4.1_ CHARACTERISTICS / PERFORMANCE

DYNAMICS, POWER & ACCURACY

Structural bodies of maximum rigidity optimised by finite elements (FEM). X / Y / Z axes over linear guides with preloaded rolling shoes with two rows of circulating rollers. Rectified ball screws of high precision with preloaded double nuts for the longitudinal axis movement. Geometric verification with direct measurement systems on the 5 machining axes (linear and rotary).

New thermo-symmetrical and thermostable structure design complemented with digital thermal twin models. Thermal compensation system on the electrospindle and heat source isolation.



THC | B AXIS HEAD



THR | A AXIS HEAD



SUPERIOR TECHNOLOGY B or A AXIS HEADS_

- TORQUE MOTOR technology.
- Fast, continuous and accurate movements.
- Measured by rotary scale.
- Turning torque S1: 1210 Nm
- Clamping force: 7000 Nm
- Cast iron turning body housing.

DIRECT DRIVE TECHNOLOGY NC ROTARY TABLES

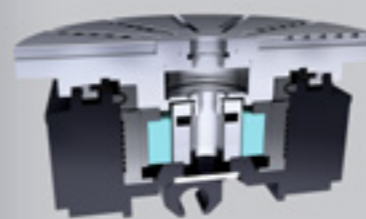

Available in all the range_
Maximum dynamics in turning operations and positioning accuracy in milling operations, without the need for additional mechanical devices or the use of position locking.

- High dynamics and torque: Up to 500 rpm - 12.000 Nm.
- High power, up to 120 kW.
- High workpiece weight, up to 22.500 kg.

- **Positioning (ISO 230-2): 6 µm**
- **Repeatability (ISO 230-2): 5 µm**

*Data based on the T12 model

PRECISION PLUS PERFORMANCE CONCEPT

Optional machine manufacturing measures:

- Machine manufacturing in thermo stable assembly area.
- Structural finishing by hand scraping manufacturing.

Integral cooling measures to improve the thermal behaviour of the machine:

- 1_ Spindle head**
 - Motorised electrospindle.
 - Direct Drive torque motor B axis.
 - Direct Drive torque motor A axis.
- 2_ Rotary table**
 - Bearing.
 - Direct Drive torque motor.
- 3_ Basic structure**
 - X / Y / Z axis motors.
 - Support motors X / Y / Z axes.
 - Ball screw nut support X / Y / Z axes.
 - Bearing support combined Z axis.
 - Cooler with PID control.
 - Cooler for coolant with PID control.

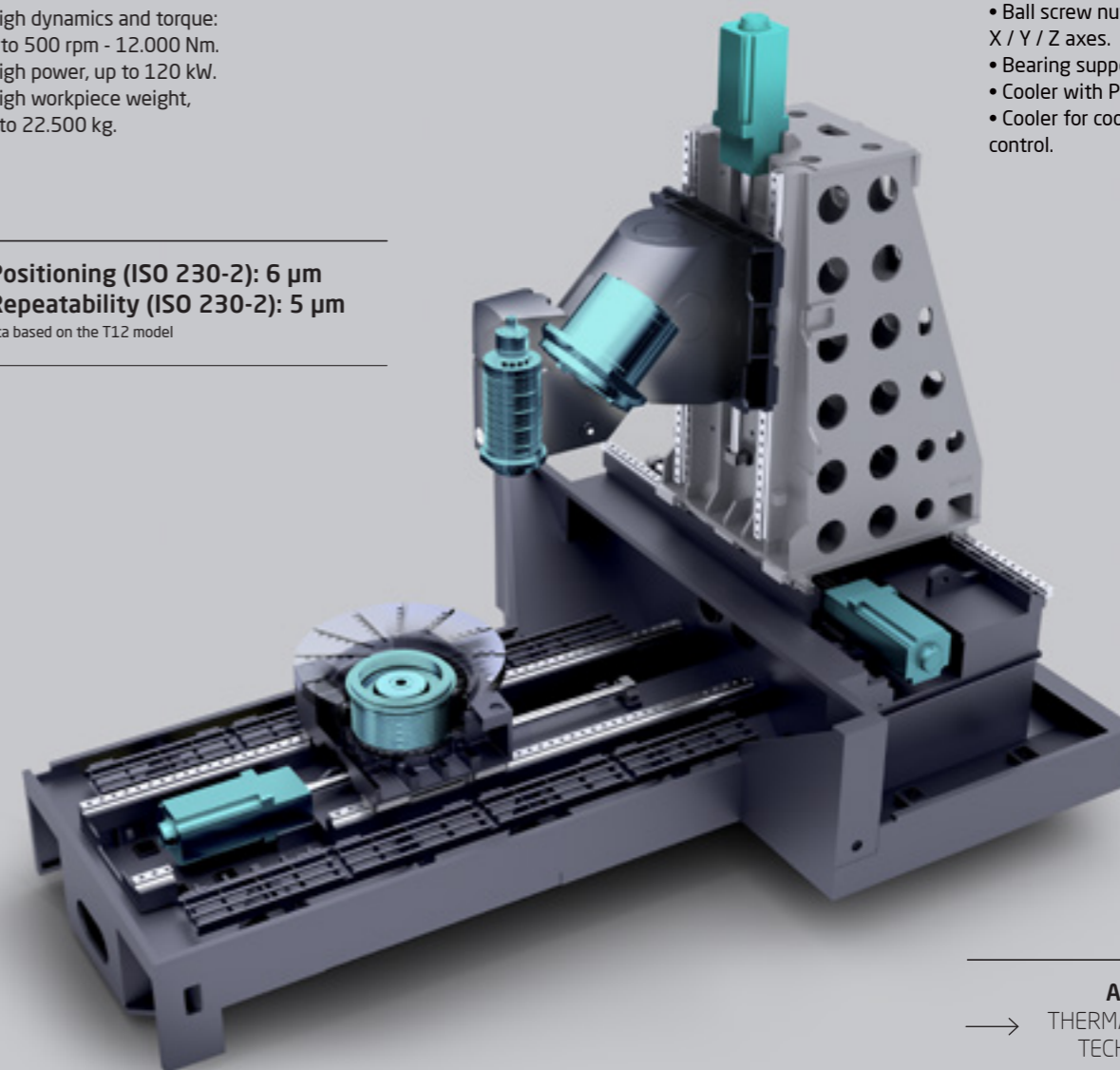

→ **ACTIVE THERMAL CONTROL TECHNOLOGY**

- [1_ General view](#)
- [2_ Application industries](#)
- [3_ Advantages](#)
- [4_ Characteristics](#)
- [4.2_ Eco & Ergo Design](#)
- [5_ Machine Configuration](#)
- [6_ The range](#)
- [7_ Technological integration](#)
- [8_ Technical data](#)

IBARMIA ECO DESIGN

Design by means of FEM method, oriented to the structural optimisation of the machine, which integrates various systems to reduce energy consumption:

- MQL lubrication avoiding pumps and their consumption
- Grease lubrication
- LED lighting
- More efficient servomotors

- Self-regulation of consumption by means of intelligent functions for automatic switch-on and switch-off of the machine.
- Technological cycles for more efficient performance.

20%

REDUCTION
In environmental impact

4_ CHARACTERISTICS / EFFICIENCY

ECO & ERGO DESIGN

Machines designed with the aim of optimising energy consumption throughout their life cycle; machines conceived for the highest efficiency in the machine-user relationship, which translates into improved accessibility and usability.

ECOLOGY AND ECONOMY CAN GO HAND-IN-HAND INTEGRATING "GREEN" PARAMETERS INTO THE MACHINE DESIGN PHASE AND IT'S FUTURE PERFORMANCE

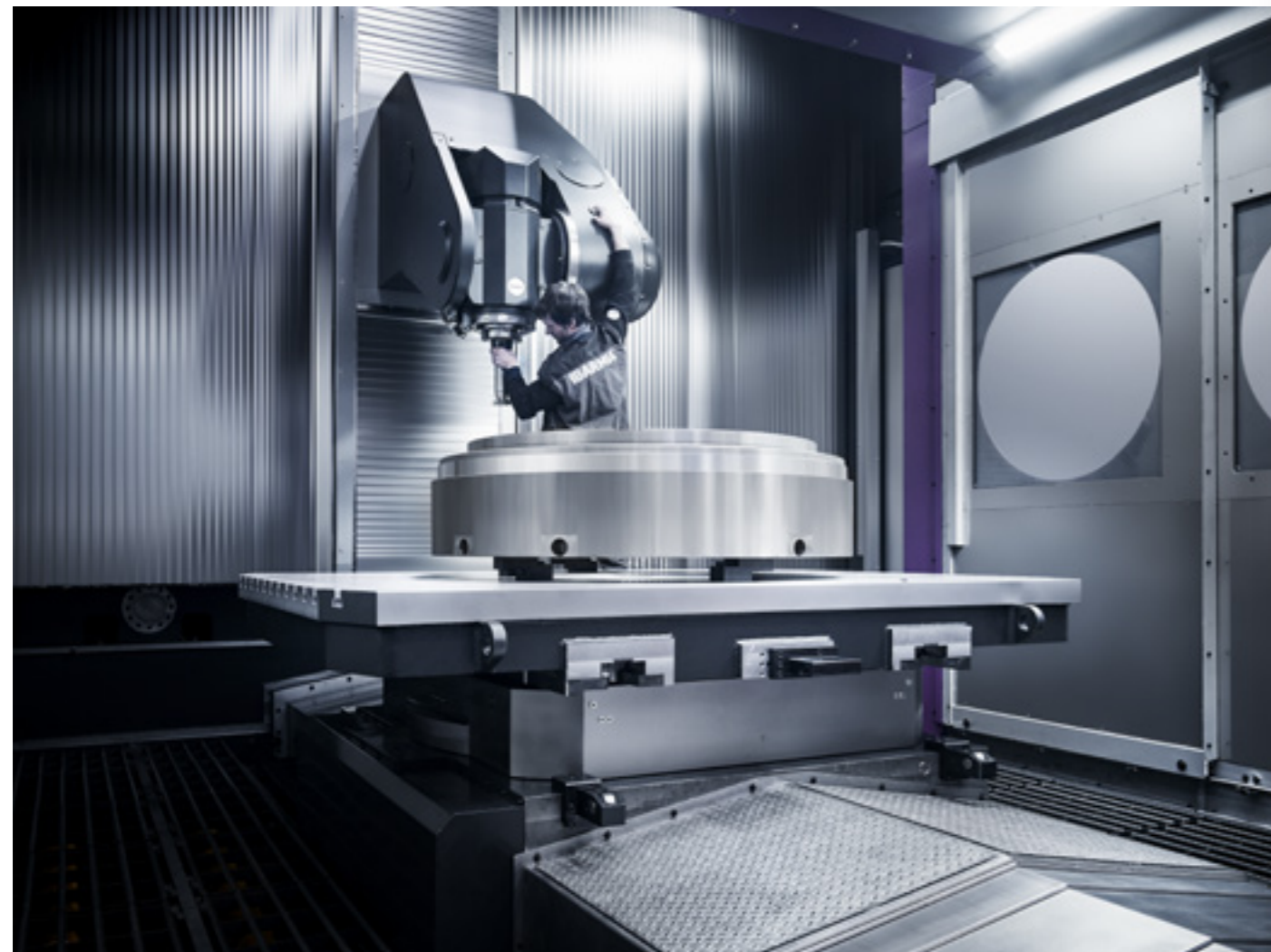

IBARMIA ERGO DESIGN

A machine designed for an optimum interaction with the operator.

- Motorised door opening to avoid physical efforts.
- Full and immediate access to a working area with folding slats in all the inside of the machine.
- Easy part loading-unloading and preparation. The operator can move around the table, making the access and cleaning of the endless screw area easier.

- Ergonomic working height optimized table height avoiding uncomfortable postures for the operator.
- An easy top access for loading / unloading parts by crane.
- Total closing of the workin area to reduce the acoustic and environmental contamination.
- Easy to identify and accessible control functions, to minimise mental fatigue of the operator.
- Light and moving control panel.

FULL ACCESS TO THE MACHINE BOTH IN MACHINING AS VERIFICATION AND MAINTENANCE OPERATIONS



- [1_ General view](#)
- [2_ Application industries](#)
- [3_ Advantages](#)
- [4_ Characteristics](#)
- [5_ Machine Configuration](#)
- [5.1_ Single table machine](#)
- [6_ The range](#)
- [7_ Technological integration](#)
- [8_ Technical data](#)

THE FLEXIBILITY OF THE T SERIES IS SUPPORTED BY 450 STANDARD OPTIONS. HOWEVER, SPECIAL OPTIONS ARE DEVELOPED ADHOC FOR THE SPECIFIC NEEDS OF CUSTOMERS



5.1_ SINGLE TABLE MACHINE

SINGLE TABLE MACHINE CONFIGURATION

← 1_ WORKING AREA



Parts up to
h 1600 mm / 4.500 Kg
Linear axes (mm)
X 1200 Y 1300 Z 1000
Axes can be increased up to
Y +150 / 300 Z +200



Parts up to
h 1700 mm / 6.000 Kg
Linear axes (mm)
X 1600 Y 1600 Z 1200
Axes can be increased up to
Y +150 / 300 Z +300



Parts up to
h 1750 mm / 10.000 Kg
Linear axes (mm)
X 2200 Y 1600 Z 1500
Axis can be increased up to
Z +200



Parts up to
h 1950 mm / 20.000 Kg
Linear axes (mm)
X 3000 Y 2000 Z 1700
Axis can be increased up to
Z +200



Parts up to
h 2150 mm / 25.000 Kg
Linear axes (mm)
X 3600 Y 2300 Z 1900

2_ TILTING HEADS



THC_ B axis head
-15°/+195°
Overhanging can be increased up to 125 mm



THR_ A axis head
-45°/+135°
Overhanging can be increased up to 125 mm

3_ ROTARY TABLES



MULTIPROCESS
Milling-Turnin rotary table
Direct Drive transmission



EXTREME
Milling rotary table
Direct Drive transmission



EXTREME
Milling rotary table

4_ TOOL & HEAD MANAGEMENT



Chain Linear ATC
Modullar increasing.
From 60 to 360 tools.
Up to 600 mm / 30 kg.



Integrated Pick ups
For special tools and heads.
Configurable layout.



Compact Polar ATC
Configurable layout.
134 or 255 tools.



Large capacity Polar ATC
Managed by arm robot.
Configurable layout.
Up to 400 tools.



Arm robots
Two configurations for
40 and 100 kg.

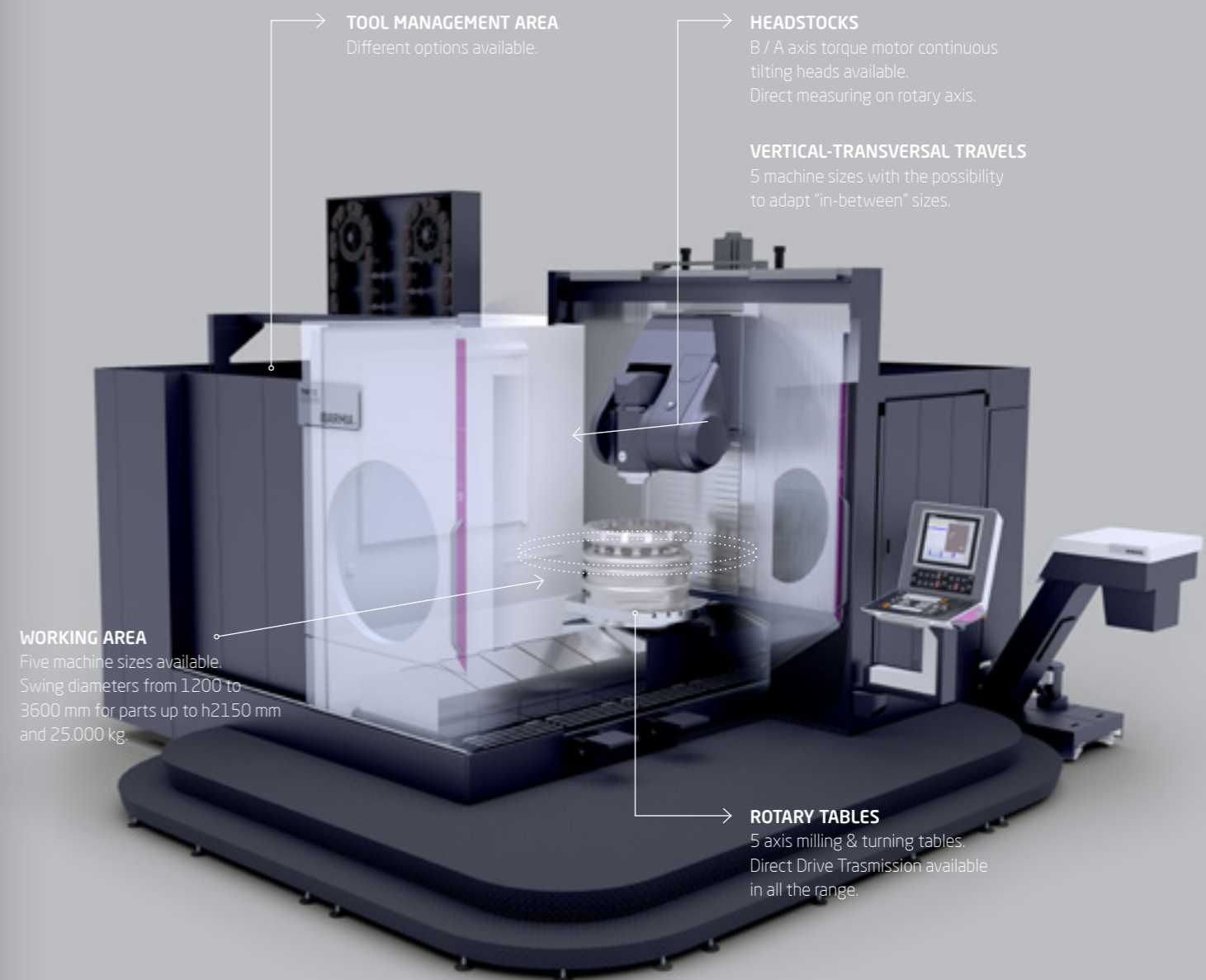

TOOL MANAGEMENT AREA
Different options available.

HEADSTOCKS
B / A axis torque motor continuous tilting heads available.
Direct measuring on rotary axis.

VERTICAL-TRANSVERSAL TRAVELS
5 machine sizes with the possibility to adapt "in-between" sizes.

WORKING AREA
Five machine sizes available.
Swing diameters from 1200 to 3600 mm for parts up to h2150 mm and 25.000 kg.

ROTARY TABLES
5 axis milling & turning tables.
Direct Drive Transmission available in all the range.

T MACHINES BASIC STRUCTURE
(IN THE PICTURE THR 12 MODEL)

- 1_ General view
- 2_ Application industries
- 3_ Advantages
- 4_ Characteristics
- 5_ Machine Configuration
- 5.2_ Machine with pallet changing
- 6_ The range
- 7_ Technological integration
- 8_ Technical data



5.2_ MACHINE WITH PALLET CHANGING

AUTOMATIC PALLET CHANGER CONFIGURATION

Starting from the basic configuration of the machine, IBARMIA offers different pallet changing solutions to increase productivity and minimise production and market response times.

THE FLEXIBLE MANUFACTURING SYSTEMS RESPOND TO SINGLE UNIT AND LARGE SERIES MANUFACTURING, MAKING THEM ATTRACTIVE TO COMPANIES OF EVERY SIZE AND SECTOR

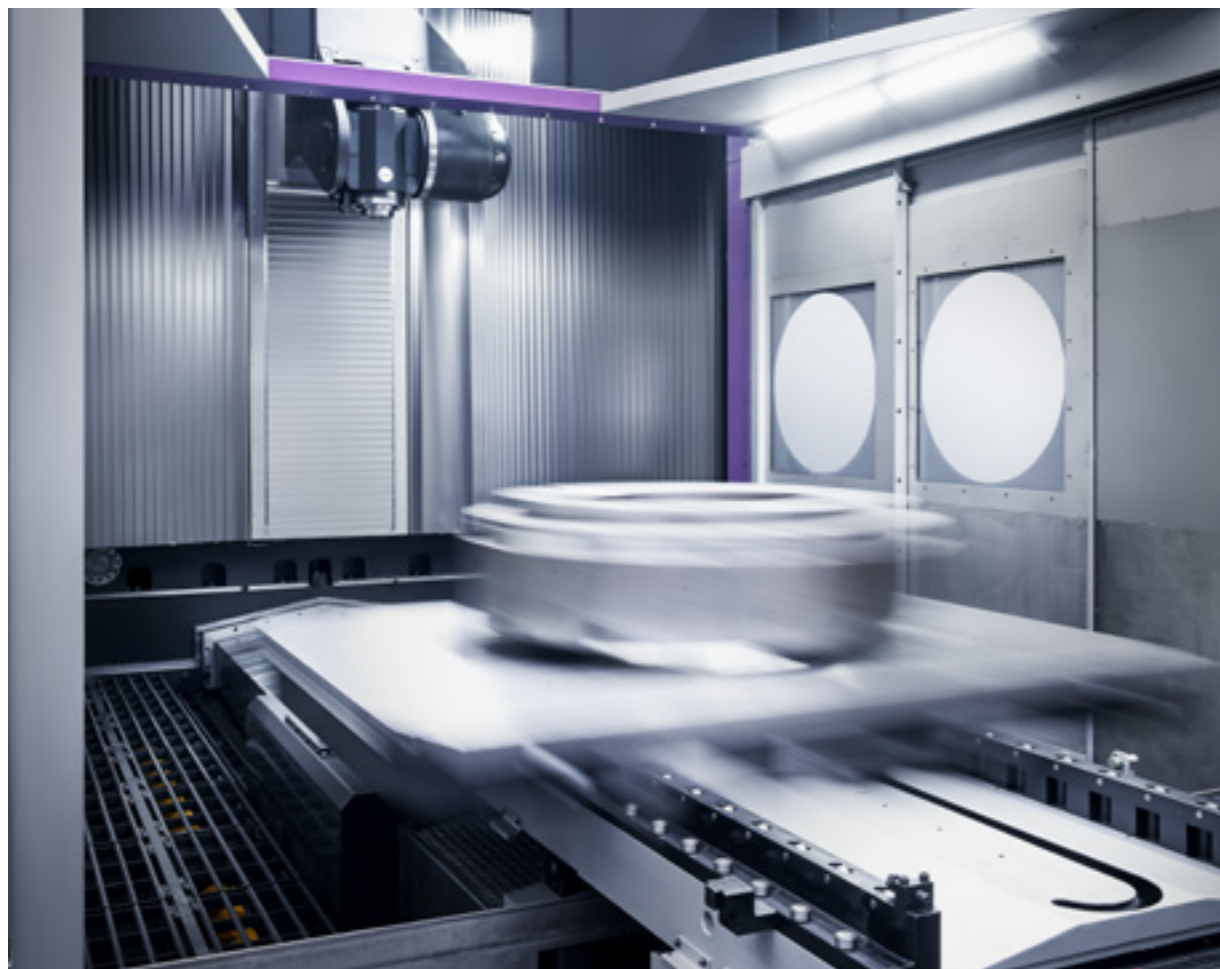

T SERIES

Automation is one of the big drivers of the current industry, due to the capacity to answer the challenge of making the machines work for as many hours as possible, or even unattended.

SYSTEM 1

ROTOPALLET_ T12 / T16 MODELS

Quick pallet changing executed by a double fork located in the machine front.

The rotopallet is a system focused to increase the machine autonomy and productivity minimizing the floor space. The operator prepares the next job during the machining process. Optionally the loading / unloading position can turn manually 4x90° for a better access to the workpiece.

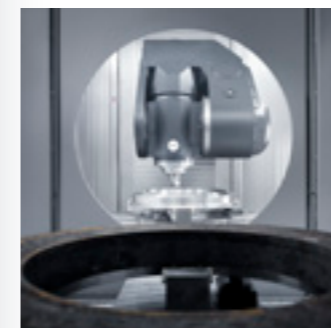

- 1_ General view
- 2_ Application industries
- 3_ Advantages
- 4_ Characteristics
- 5_ Machine Configuration
- 5.2_ Machine with pallet changing
- 6_ The range
- 7_ Technological integration
- 8_ Technical data



SYSTEM 2

PALLET POOL_
T12 / T16 MODELS

Standardized and competitive solutions cooperating with leaders in the sector.

Integrating a flexible pallet warehouse in combination with one or more T12 or T16 machining centers, these facilities offer a great storage capacity with the minimum floor space. The basic installation can be extended with additional pallets. To add flexibility to the proposal, IBARMIA offers various solutions:

- 4 x 90° Manual indexing loading/unloading station.
- Automatic indexing loading/unloading station.
- Additional stations for piece inspection, turn-over, welding etc...

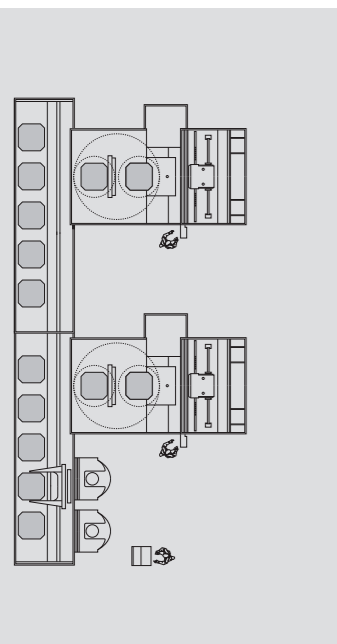
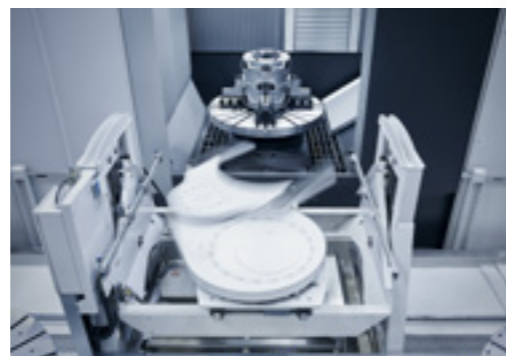
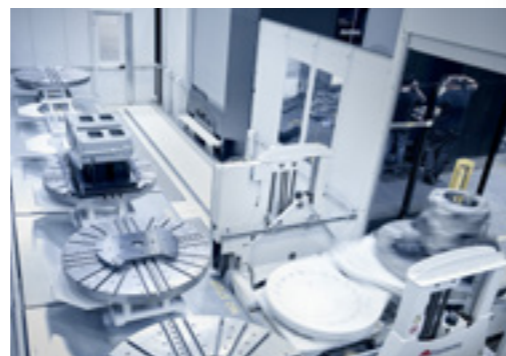

SYSTEM 3

PALLET POOL_
T22 / T30 / T36 MODELS

Due to heavier loads and bigger swing diameters, the automation system in the T22, T30 and T36 models requires different solutions than the T12 and T16 models.

The key factors to determine the number of pallets are the average cycle time of the pieces and the length of unattended use of the machine. IBARMIA offers simple modular solutions of 2 and 4 positions for the T22 / T30 / T36 models. Projects requiring a larger number of pallets can have linear storage with capacity for future growth, either for station units and/or machining units.

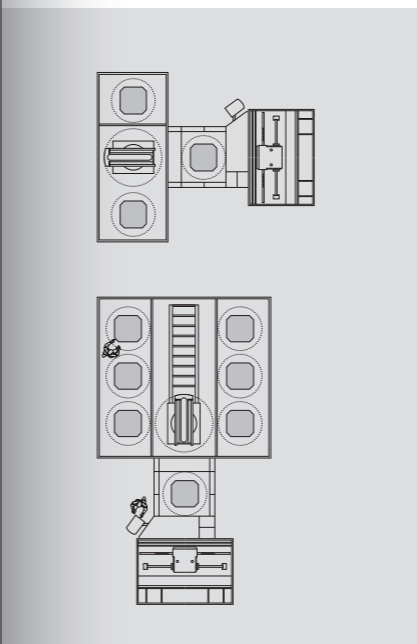
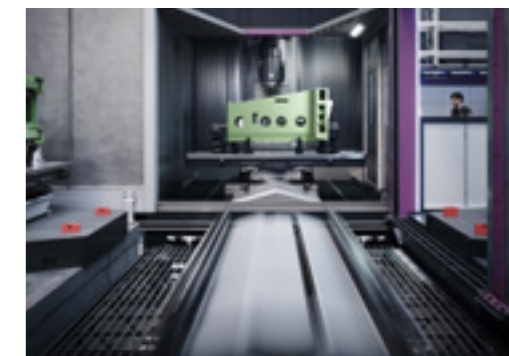

Therefore, the focus on improving productivity is permanent, minimising the production times and response to the market.

- [1_ General view](#)
- [2_ Application industries](#)
- [3_ Advantages](#)
- [4_ Characteristics](#)
- [5_ Machine Configuration](#)
- [5.3_ Machine equipment summary](#)
- [6_ The range](#)
- [7_ Technological integration](#)
- [8_ Technical data](#)

5.3_ MACHINE EQUIPMENT SUMMARY

THE STANDARD MACHINE MAIN CHARACTERISTICS

A high level of standard equipment makes these models focused on high productivity in advanced manufacturing a reference in terms of ergonomics and performance.

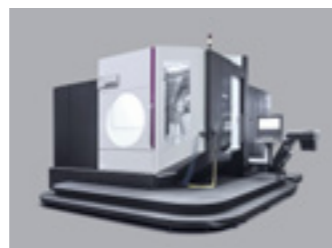

Stairs for an easy access to the working area.



Totally encapsulated working area and safety windows.



Illuminated working area. Working area without horizontal planes and smooth top.



Standard convertible roof facilitating the loading/unloading of pieces by crane.



Moving control panel with 19" touch screen.



60 positions chain driven tool magazine with servomotors.



Station for agile manual feeding of tools to the magazine.



Chip conveyor with integrated coolant tank.



Climatized electric cabinet with easy access, isolated from heat-sources.

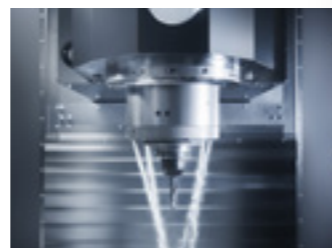

External coolant system around the spindle.

Subject to change without prior motive. Informative contents are not binding.



T SERIES

Other standard items

- Travelling on lineal guides and ball screws.
- Direct measuring on X / Y / Z axes.
- Measuring by rotary scale on B axis and C axis.
- Hydraulic counterweight for the head.
- Servomotors with braking system for the axes.
- Longitudinal endless screws for chip evacuation.



THC_ B axis head
Maintain the same tool center point across the full range

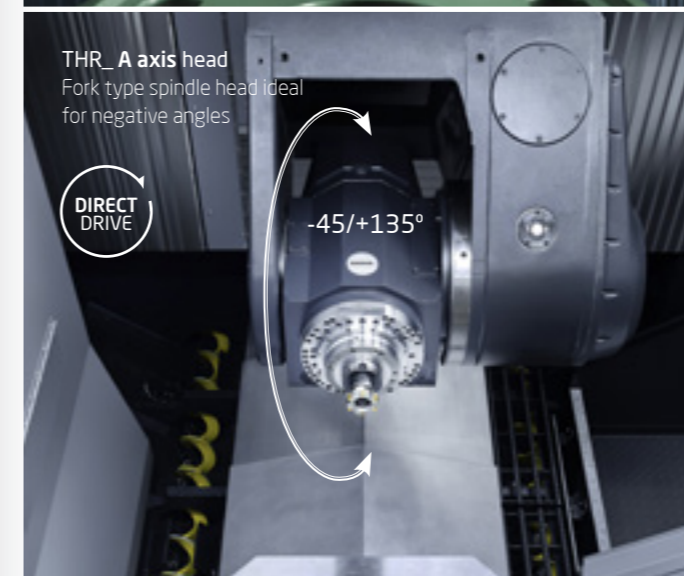

THR_ A axis head
Fork type spindle head ideal for negative angles

DIRECT DRIVE TRANSMISSION B or A AXIS HEADS_

- TORQUE MOTOR technology.
- Fast continuous and accurate movements.
- Measured by rotary scale.
- Backlash free.
- Extraordinary precision.
- Maintenance reduction.
- Positioning accuracy: 10"
- Turning torque S1: 1210 Nm
- Turning torque peak value: 2120 Nm
- Clamping force: 7000 Nm



MULTIPLE CNC CONTROL PLATFORM IN ALL MODELS_

Latest generations of CNC controls of the most prestigious manufacturers. Freedom to choose among these user platforms.

- HEIDENHAIN
- FANUC
- SIEMENS

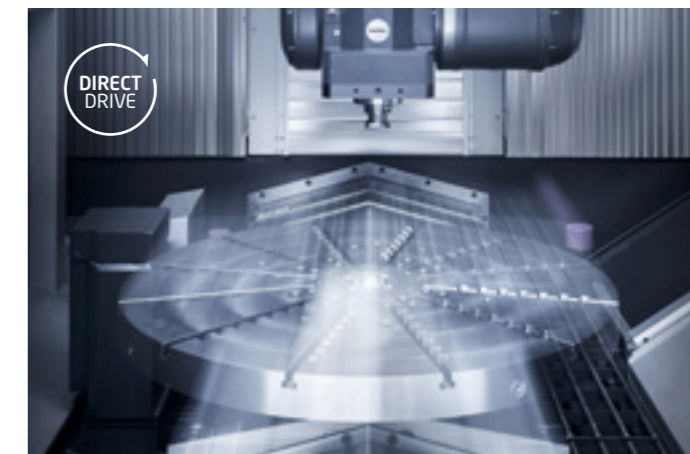

DIRECT DRIVE TRANSMISSION WORKING ROTARY TABLES_

- TORQUE MOTOR technology.
- Maximum dynamics in turning operations and positioning accuracy in milling operations, without the need for additional mechanical devices or the use of position locking.
- Max speed up to 500 rpm
- Nominal torque up to 12.000 Nm
- Max power up to 120 kW
- Max load up to 22.500 kg

- [1_ General view](#)
- [2_ Application industries](#)
- [3_ Advantages](#)
- [4_ Characteristics](#)
- [5_ Machine Configuration](#)
- [5.3_ Machine equipment summary](#)
- [6_ The range](#)
- [7_ Technological integration](#)
- [8_ Technical data](#)

5.3_ MACHINE EQUIPMENT SUMMARY

OPTIONAL ITEMS SUMMARY TO COMPLETE THE RANGE VIEW

The FLEXIBILITY of T SERIES machines is supported by 450 Standard options. However, Special options are developed ad-hoc for the specific needs of our costumers.



120-240-360 positions chain driven tool magazine with servomotors.



134 or 255 positions compact polar tool magazines.

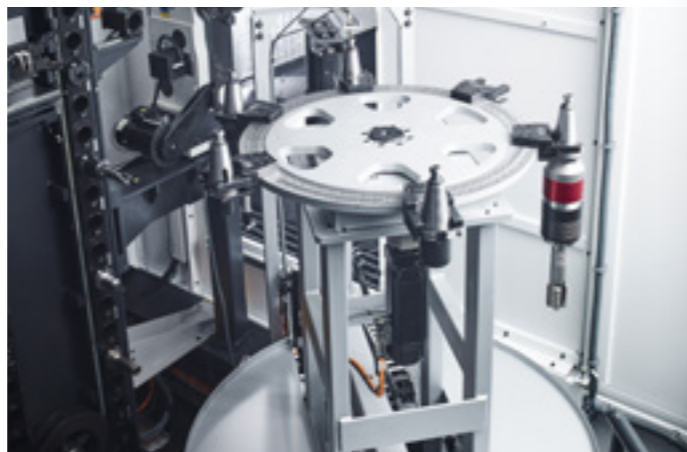

INTEGRATED PICK UPS
For the management of long and/or heavy tools, which offer an ergonomic and simple compact solution to expand the range of available tools.

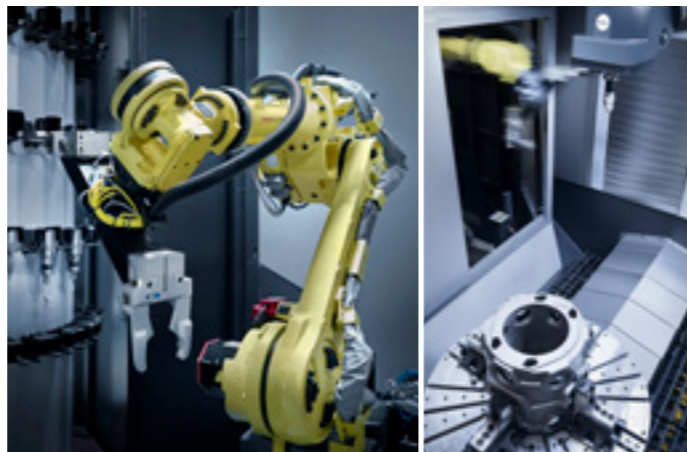

LARGE CAPACITY POLAR TOOL MAGAZINES
Managed by arm robot, combining tool changing with special tools and heads changing.



T SERIES

- Other optional items**
- Coolant through spindle.
 - Steam and mist aspiration system.
 - "Illumination" pack with LED lights with acoustic signal indicating the state of the machine, integrated into the machine fairing.
 - Lights with acoustic signal indicating the machine status.
 - Camera settings and display mode.
 - Control with touch screen up to 24"

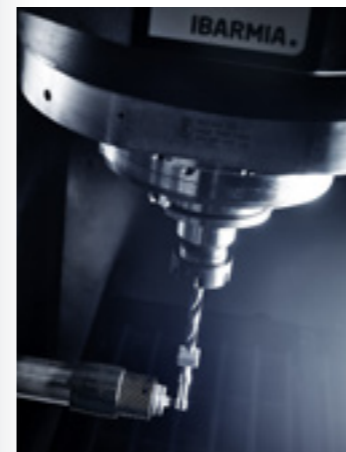

MACHINE PRESETTING DEVICES
The program offers the possibility of add a wide range of tool measuring and touch systems integrated in the machine.

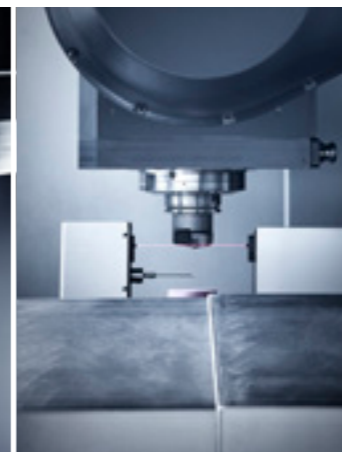

VARIOUS AUTOMATIC PALLET CHANGING SYSTEMS AVAILABLE
IBARMIA offers different degrees of automatic pallet changers for a perfect adaptation to specific production requirements.



PRECISION PLUS PERFORMANCE CONCEPT
Optional machine manufacturing measures. / Integral cooling measures for improving the machine thermal behaviour.

MACHINE THERMAL BEHAVIOUR IMPROVING

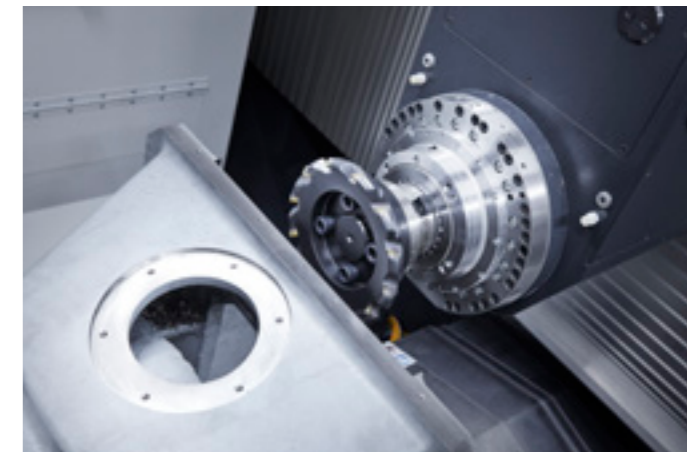

A WIDE RANGE OF ELECTROSPINDLES AVAILABLE
The program offers a large variety of spindles available, to cover from high dynamics machinings to works on the hardest materials by high torque spindles.

DIGITAL TECHNOLOGY ELECTROSPINDLES

- 1_ General view
- 2_ Application industries
- 3_ Advantages
- 4_ Characteristics
- 5_ Machine Configuration
- 6_ The range
- 6.1_ T MULTIPROCESS
- 7_ Technological integration
- 8_ Technical data

AT THE FOREFRONT OF TECHNOLOGY, MULTIPROCESS MACHINES REDUCE TIME AND ERRORS WHILE INCREASING PRODUCTIVITY CONSIDERABLY

6.1_ T MULTIPROCESS MACHINES

T MULTIPROCESS
5 AXIS UNIVERSAL MULTITASKING MACHINING CENTERS

The MULTIPROCESS concept improves the quality of the parts by using fewer machines and therefore fewer set-ups, reducing the initial investment cost by requiring fewer machines with a smaller footprint, and simplifying industrial management by eliminating the transit of parts between machines.

- 5 Axis Milling
- Turning
- Mill-turning
- Drilling
- Threading
- Boring
- U axis boring
- Grinding
- Gear power skiving
- Gear hobbing

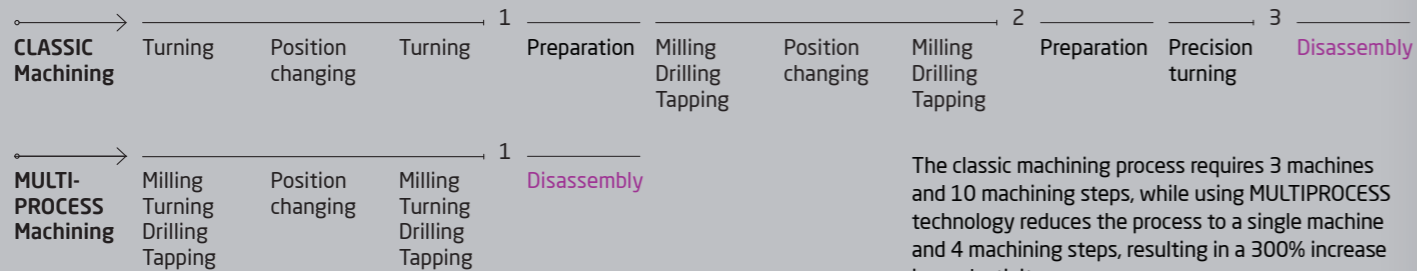

The classic machining process requires 3 machines and 10 machining steps, while using MULTIPROCESS technology reduces the process to a single machine and 4 machining steps, resulting in a 300% increase in productivity.

300%
Productivity improve

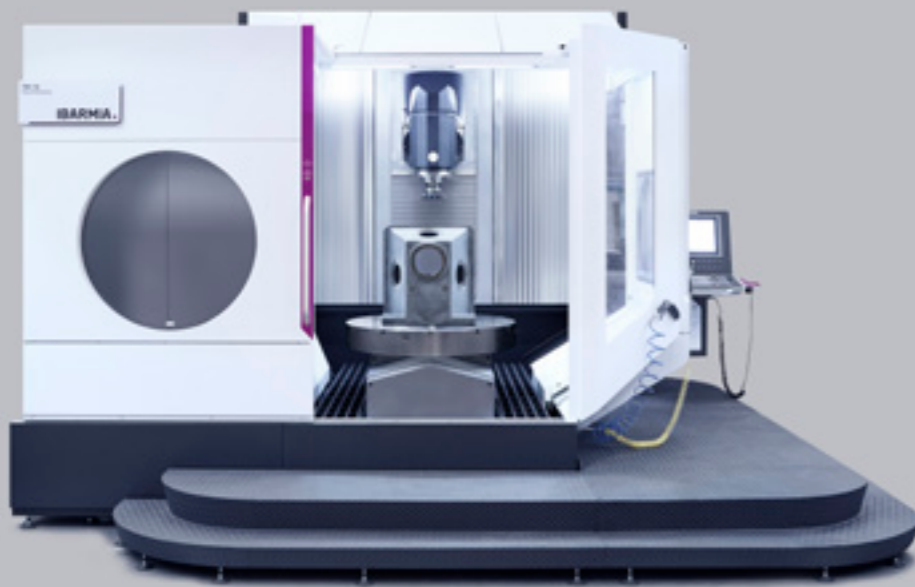

MANUFACTURING TECHNOLOGY



Table diameter
ø1000 mm
Maximum turning speed
500 rpm
Maximum load capacity*
2250 kg / 4500 Kg



Table diameter
ø1200 mm
Maximum turning speed
500 rpm
Maximum load capacity*
3000 kg / 6000 Kg



Table diameter
ø1600 mm
Maximum turning speed
400 rpm
Maximum load capacity*
6000 kg / 10.000 Kg



Table diameter
ø1800 mm
Maximum turning speed
200 rpm
Maximum load capacity*
14.000 kg / 20.000 Kg



Table diameter
ø2000 mm
Maximum turning speed
150 rpm
Maximum load capacity*
16.000 kg / 22.500 Kg

*Turning / Milling



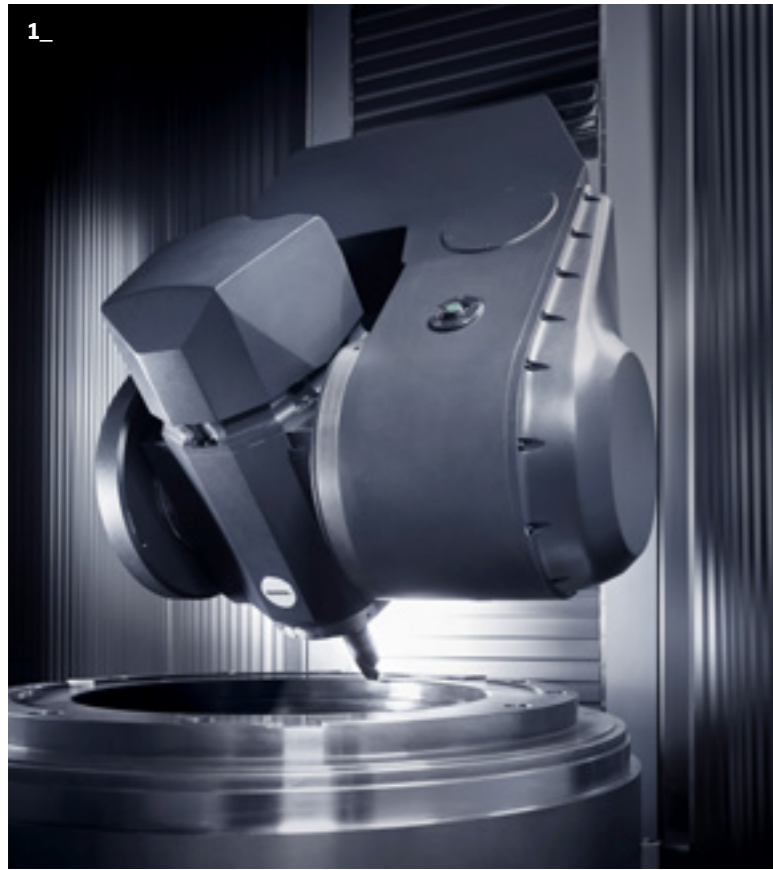

1_ THR 30 MULTIPROCESS: Model equipped with an A-axis THR spindle for machining negative angles ($+45^\circ / -135^\circ$). With a maximum turning diameter of 3000 mm, it allows turning operations at a maximum of 200 rpm on workpieces up to 14t.

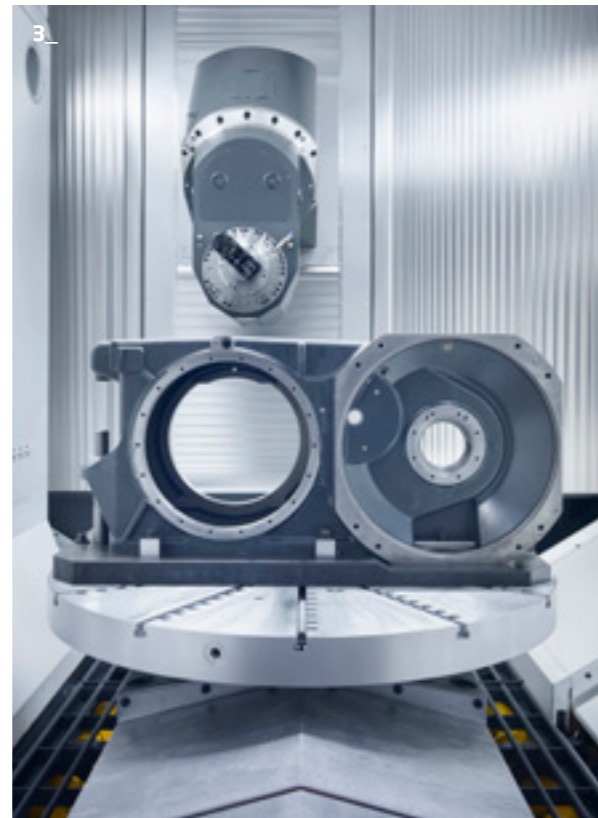

2-3_ THC 16 MULTIPROCESS with universal B-axis head ($-15^\circ/+195^\circ$). This multitasking machining centre has been adapted to the customer's needs, having increased the vertical travel by 300 mm, and is intended for the manufacture of different parts for the automotive sector.

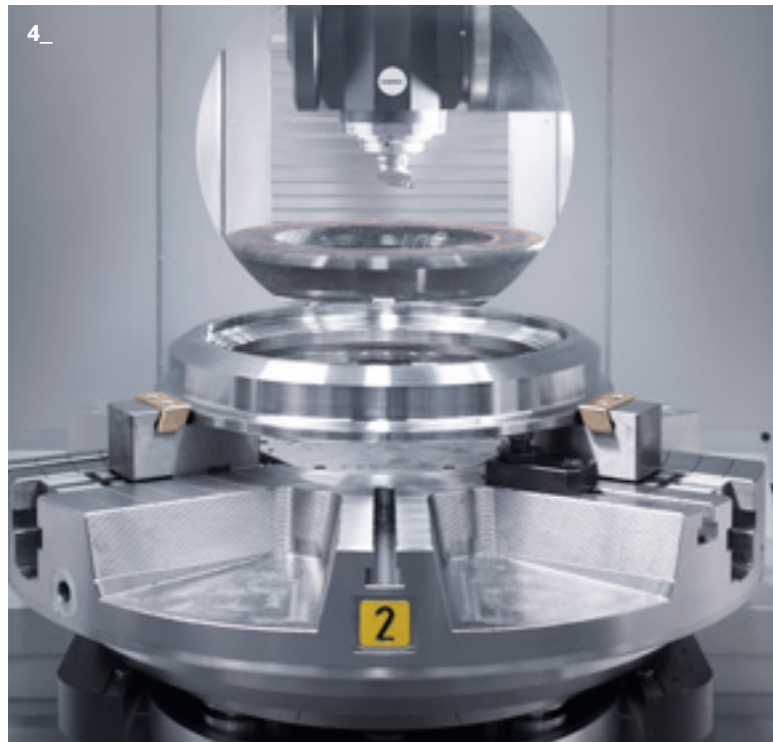

4_ THR 12 MULTIPROCESS equipped with Rotopallet for the maintenance of metro-train wheels. Top of the range among models with pallet changing (see page 19), this system increases the production and autonomy of the machine while minimising its occupation in plant.

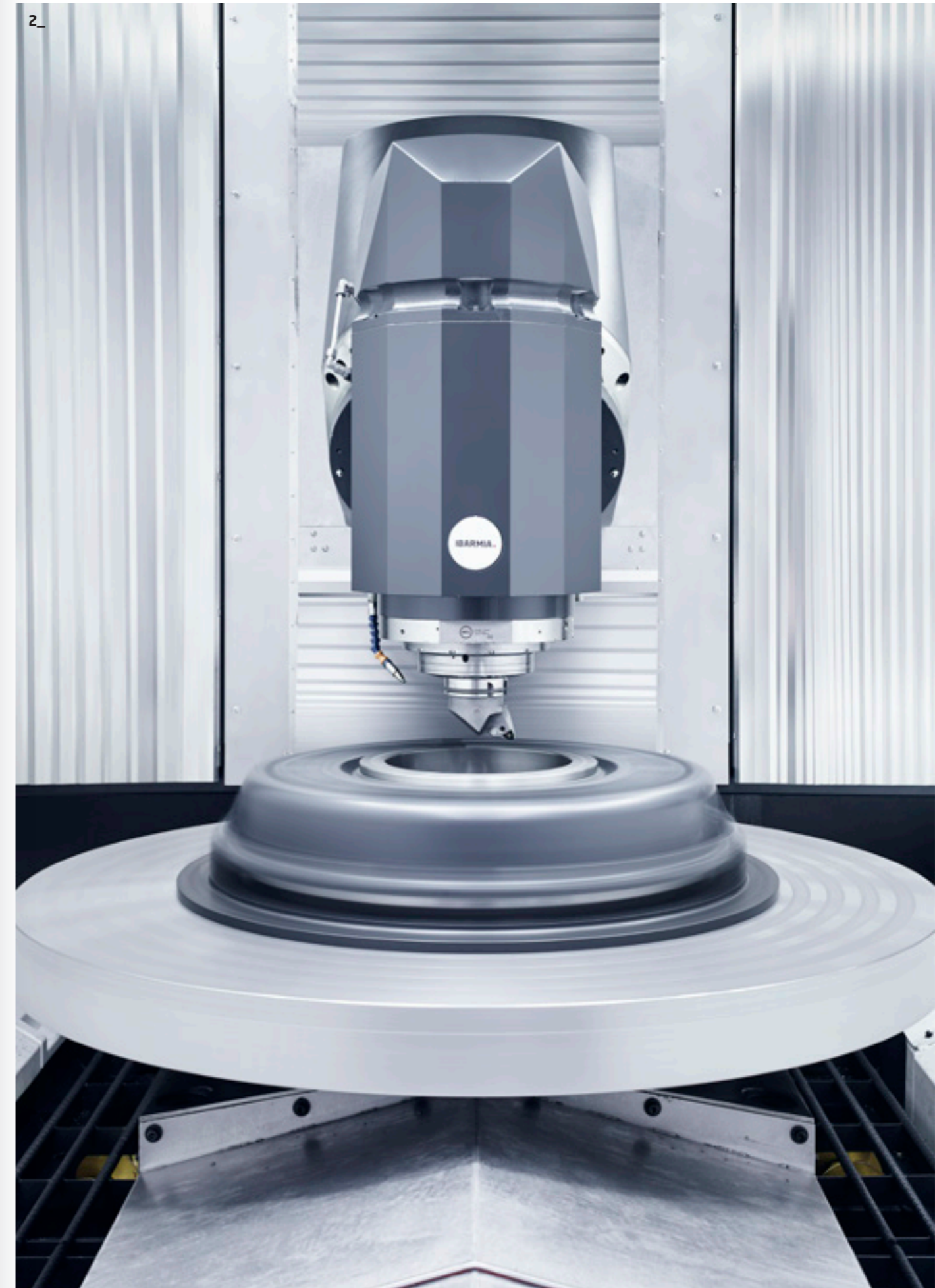

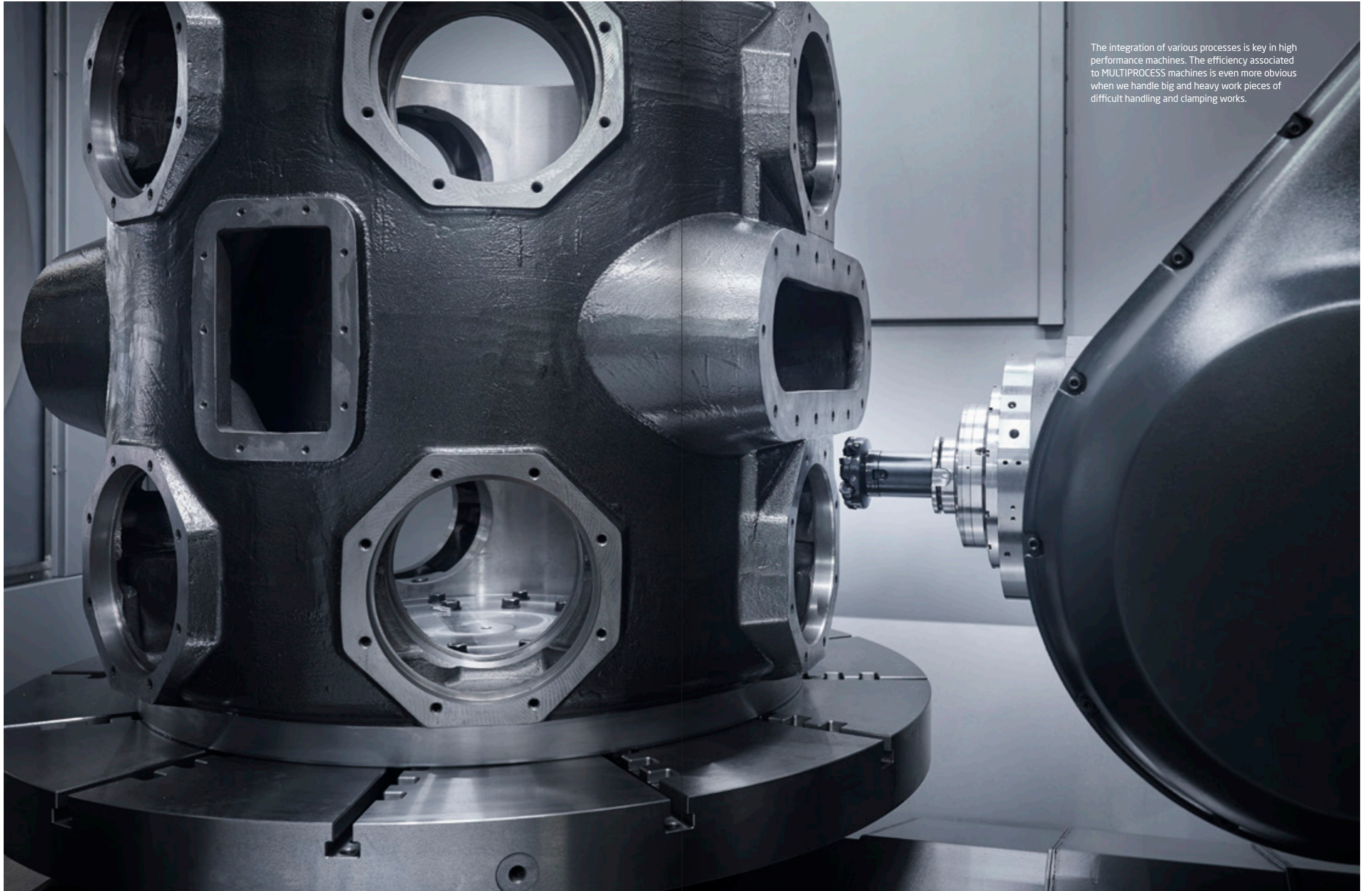

The integration of various processes is key in high performance machines. The efficiency associated to MULTIPROCESS machines is even more obvious when we handle big and heavy work pieces of difficult handling and clamping works.

- 1_ General view
- 2_ Application industries
- 3_ Advantages
- 4_ Characteristics
- 5_ Machine Configuration
- 6_ The range
- 6.2_ T EXTREME
- 7_ Technological integration
- 8_ Technical data

THE PERFECT SOLUTION FOR ADVANCED MACHINING OF MEDIUM TO LARGE WORKPIECES IN ONE SET UP

6.2_ T EXTREME MACHINES

T EXTREME
5 AXIS UNIVERSAL MACHINING CENTERS

The efficiency associated with the multi-axis models is of great importance in the T Series machining centres, as they allow machining in a single set-up on 5 faces and inclined planes, large volume parts whose handling and clamping are very demanding, thus avoiding unproductive set-ups to the benefit of the final precision and quality of the workpieces.

- Max feed on X, Y, Z axes, up to 60 m/min
- Accelerations up to 5 m/s²
- Tool change time "chip to chip" up to 7s*

*Data based on the T12 model

-
- 5 Axis Milling
 - Drilling
 - Threading
 - Boring
 - U axis boring
 - Grinding
 - Gear hobbing

The ability to tackle a wide range of machining operations in a single set-up, combined with the high dynamics of the linear axes of these models, leads to a significant reduction in manufacturing times, a vital aspect in many sectors where the every-second saving provided by the high speed of vacuum movements is a key competitive factor.

GLOBAL MACHINE DYNAMIC IMPROVEMENT IN X, Y, Z, LINEAR AXES IN T12 & T16 MODELS

60%

Average increase in Acceleration and Speeds

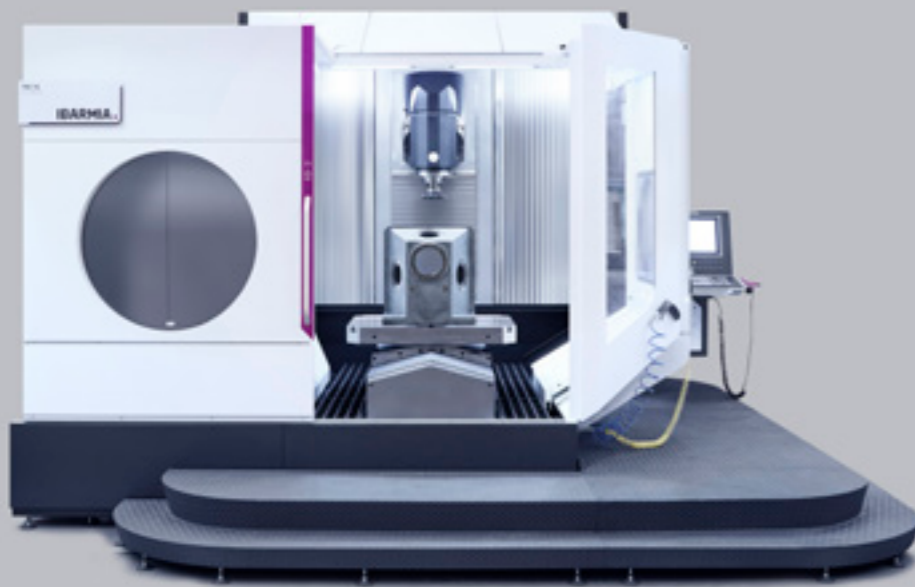

MANUFACTURING TECHNOLOGY



Table size
800 x 800 mm
Maximum load capacity
4000 Kg
Maximum turning speed
50 rpm



Table size
1000 x 1000 mm
Maximum load capacity
6000 Kg
Maximum turning speed
40 rpm



Table size
1250 x 1250 mm
Maximum load capacity
10.000 Kg



Table size
1250 x 1600 mm
Maximum load capacity
20.000 Kg



Table size
1.600 x 1.600 mm
Maximum load capacity
25.000 Kg

→ HIGH PRODUCTIVITY OF MEDIUM DIAMETER PARTS

→ HIGH PRODUCTIVITY OF BIG DIAMETER PARTS



High Dynamics T12 & T16 EXTREME Models

IBARMIA'S T12 and T16 models combine high linear axis dynamics with the integration of DIRECT DRIVE technology on the positioning tables.

- Torque motor DIRECT DRIVE transmission positioning working tables.
- HIGH DYNAMICS technology.





1_ Above, pallet pool with four stations on a THC 30 EXTREME (model with up to $\varnothing 3000$ mm turning capacity on parts up to h1950 mm and 20t). These rotary stations for loading and unloading parts while the machine is working (2 and 3) eliminate the downtime caused by complex preparations on this type of large-volume parts (see page 21).

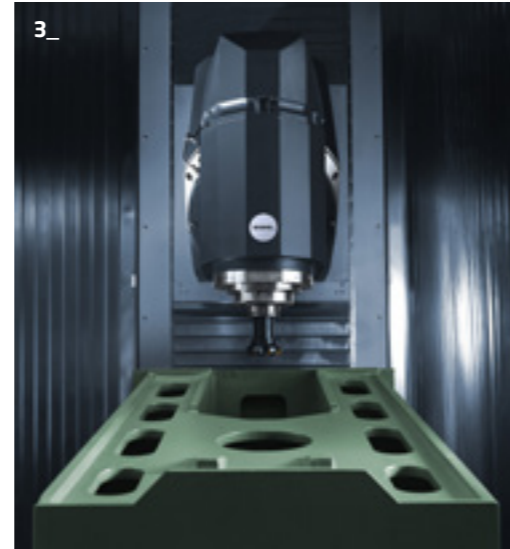

4_ Working area of a THC 16 EXTREME showing the movement of the table combining the transversal movement of the Y-axis with the C-axis rotation of the table. The double endless screw system for chip evacuation on each side of the table can be seen through a slat system that allows the operator to move freely around the table.

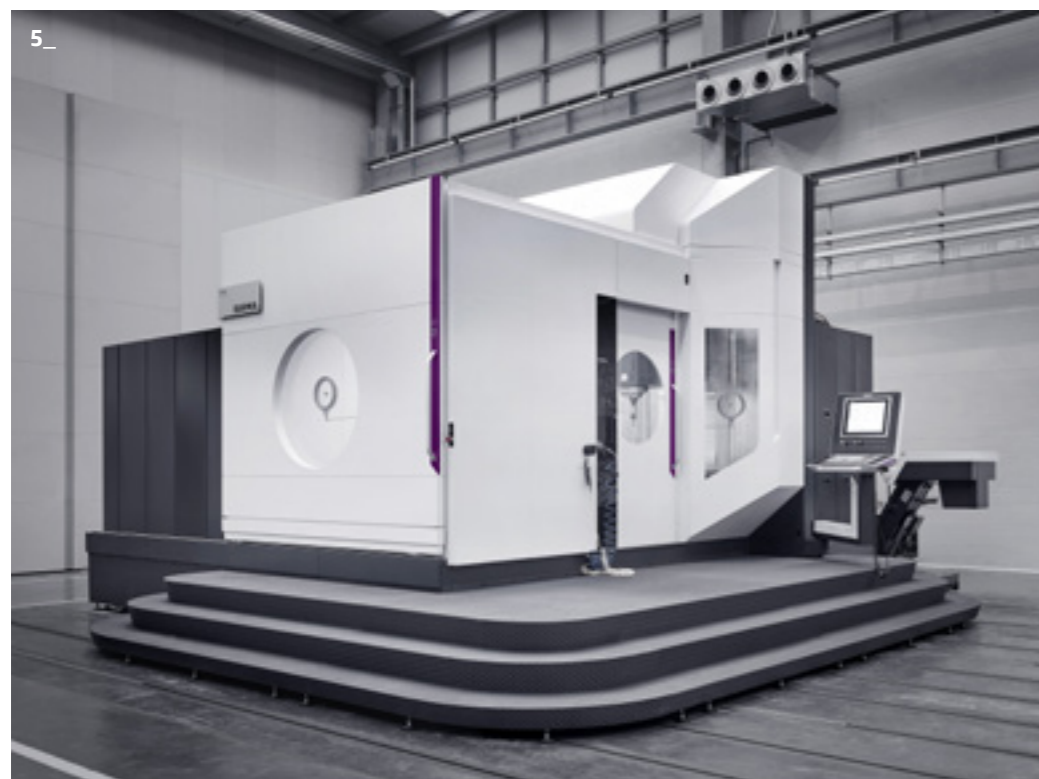
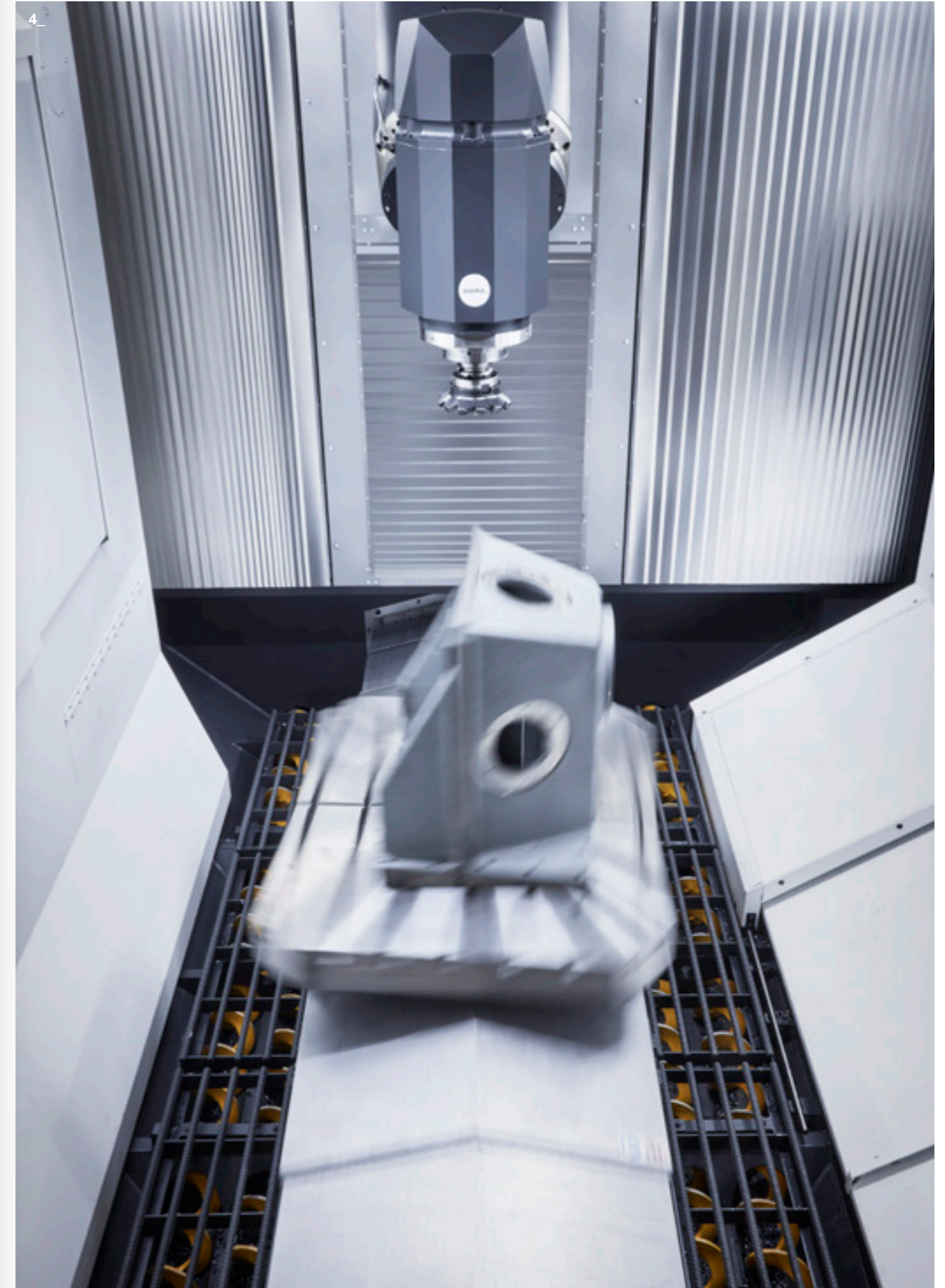

5_ THC 22 EXTREME with the working area completely encapsulated and accessible from the front and lateral sides of the machine. The stepped platform, which is standard for the 12, 16 and 22 models, allows convenient and immediate access to the machine. The T16 and T22 centres offer the option of plastering the machine, while in the case of the T30 and T36 the machine must be plastered without the access platform.

- [1_ General view](#)
- [2_ Application industries](#)
- [3_ Advantages](#)
- [4_ Characteristics](#)
- [5_ Machine Configuration](#)
- [6_ The range](#)
- [7_ Technological integration](#)
- [8_ Technical data](#)



7_ TECHNOLOGICAL INTEGRATION

ACTIVE ASSISTANCE TO THE MACHINING PROCESS

IBARMIA range of applications for active support in the manufacturing process, through connected machines equipped with the latest technology for the most demanding production needs.

Y-C AXIS AUTOTUNING

T MULTIPROCESS / T EXTREME

This applications are aimed to maximise the position loop bandwidth for variable moving masses placed on moving tables (Y axis) and rotary tables (C axis).

Main features Y axis autotuning:

- Automatic measurement of axis weight for every remarkable change in the mass on moving tables (Y) / Automatic measurement of axis inertia for every remarkable change in the mass on rotary tables (C).
- Automatic adjustment of speed and position control gains to maximise position loop bandwidth according to the specific values of mass, inertia ratios and natural frequencies in the feed drive.

Main features C axis autotuning:

- Automatic measurement of the axis inertia for every noticeable change in mass on rotary tables.
- Automatic calculation of natural frequencies and inertia ratios by means of motor consumption signals.
- Automatic limitation of maximum rotational speed of the rotary table depending on the workpiece weight, for axis protection.

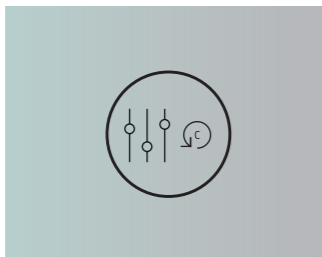
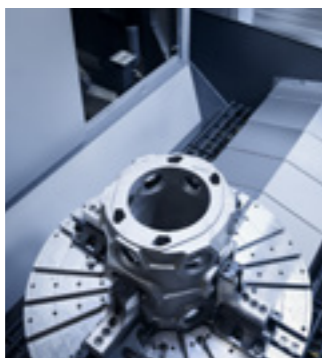
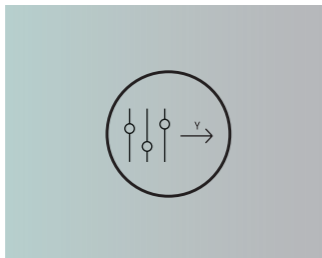

CONTROL CYCLES

ELECTROSPINDLE PROTECTION

T MULTIPROCESS / T EXTREME

This smart equipment has been designed to detect, at a very early stage, abnormal situations and disturbances that may affect the lifetime of the main spindles, especially imbalanced tools, excessive vibration during machining and collisions among spindles and machined parts.

- Monitoring of spindle unbalance during idle conditions.
- Automatic stop of spindle feed axis in case of abnormal vibrations.
- Continuous diagnosis of spindle bearings condition for preventive maintenance purposes.

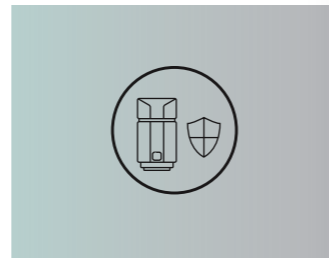

RESIDUAL UNBALANCE CHECK

T MULTIPROCESS

Unbalance reduces the life of bearings and other components, produces noise and may be a safety risk; the Rotary Axes Unbalance Compensation (RAUC) increases the life and the safety of your machine.

- Static, coupled and dynamic unbalance detection.
- Mass distribution detection.
- Balancing masses weight and location suggestion for rotary tables.

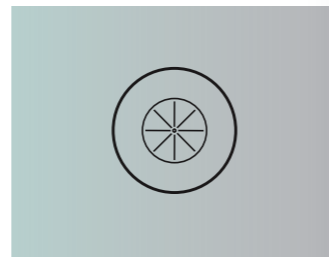
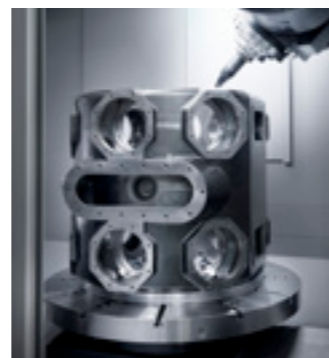

OPERATIONAL CYCLES

MILLING-TURNING

T MULTIPROCESS

High productivity thanks to complete machining on one machine in a single set-up.

- Cutting, undercutting, cutting chips, threading, etc.
- Unbalance calculation, control and monitorization.
- Storage, emission and transmission of measurement data.
- Turning of long tools in the workpiece.
- Use of multi-cutting tools.



RECTIFICADO

T MULTIPROCESS / T EXTREME

Grinding cycles for T SERIES machines.

- MULTIPROCESS models_
- External cylindrical.
- Internal cylindrical.
- Flat surfaces with flat grinding wheel (tangential contact).
- EXTREME models_
- Flat surfaces with flat grinding wheel (tangential contact).

Achievable tolerances:

- Surface quality down to 0,8 μm. Depending on the process.



T SERIES

GEAR SKIVING

T MULTIPROCESS

Synchronized rotation of tool and workpiece to be machined. Innovative manufacturing process for gears with straight or oblique gearing.

- For internal and external gearing.
- Shorter machining times.
- Fewer tools.

Achievable gear quality:

- Straight gear DIN 9 (roughing). (Depending on the gear module and diameter).
- Straight gear DIN 7 (finishing). (Depending on the gear module and diameter).

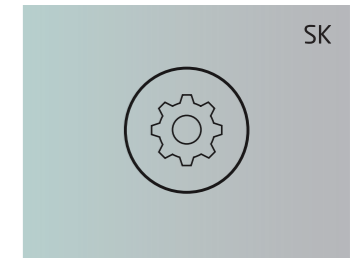
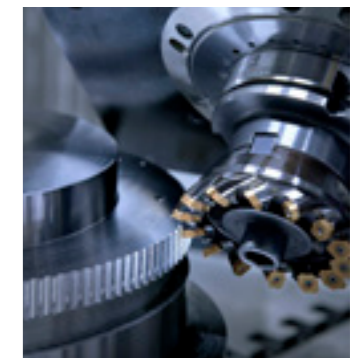

GEAR HOBBING

T MULTIPROCESS / T EXTREME

Maximum flexibility through production with standard tools on standard machines.

- Free modification of profiles, flanks and contact pattern.
- Flexible for different gears.
- Soft and hard machining on one machine.

Achievable gear quality:

- Straight gear DIN 9 (roughing). (Depending on the gear module and diameter).
- Straight gear DIN 7 (finishing). (Depending on the gear module and diameter).

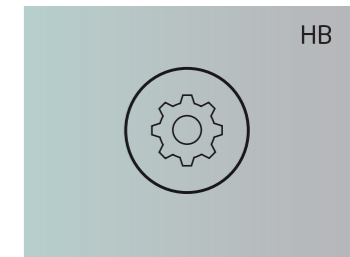

- [1_ General view](#)
- [2_ Application industries](#)
- [3_ Advantages](#)
- [4_ Characteristics](#)
- [5_ Machine Configuration](#)
- [6_ The range](#)
- [7_ Technological integration](#)
- [8_ Technical data](#)

8.1_ DIGITAL TECHNOLOGY SPINDLES

ELECTROSPINDLES_ POWER DIAGRAMS

A range of electrospindles to cover all machining needs; Dynamics and high revolutions, and high torque from very low turns for the hardest materials.

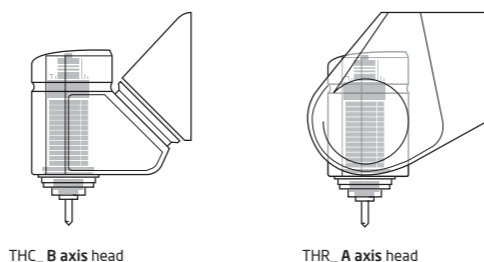

1_ STANDARD

Power and dynamics_
Up to 12.000 rpm.
74/84 kW (S1/S6).
300/452 Nm (S1/S6)

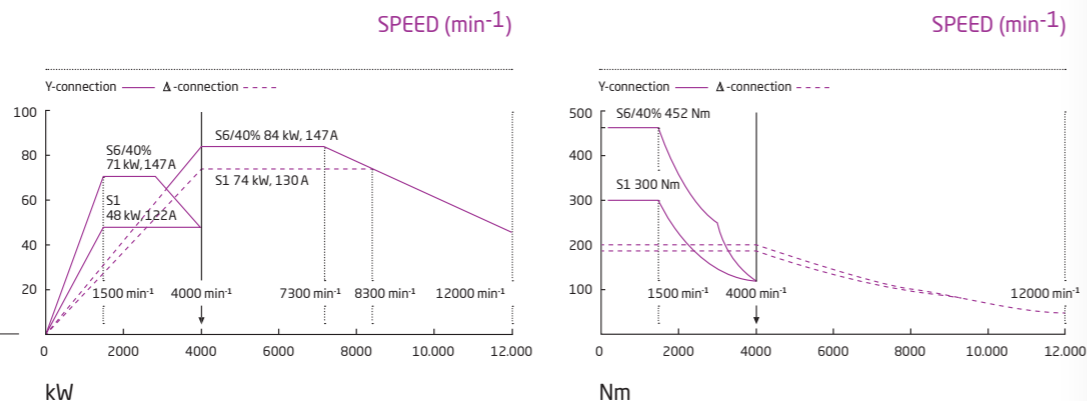

2_ OPTIONAL

High torque for the hardest materials_
Up to 7000 rpm.
52/73 kW (S1/S6).
500/700 Nm (S1/S6)

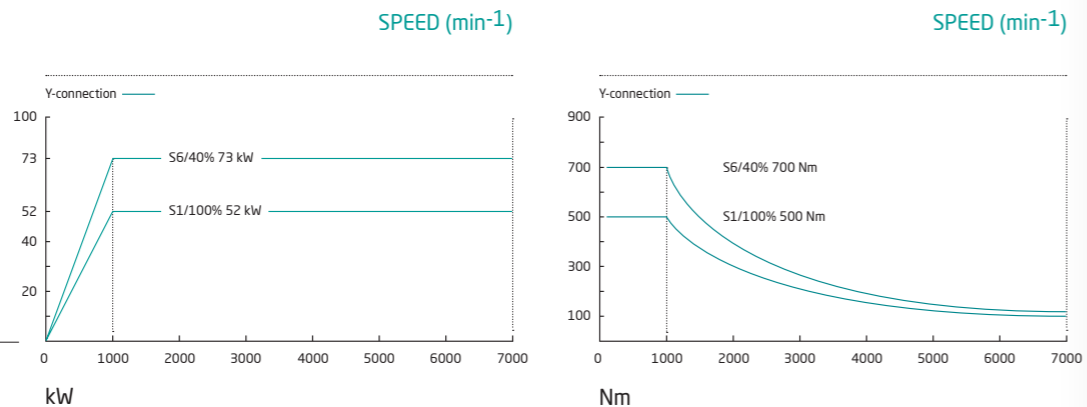

*More spindles on request



T SERIES

8.2_ MACHINING CAPACITY TEST

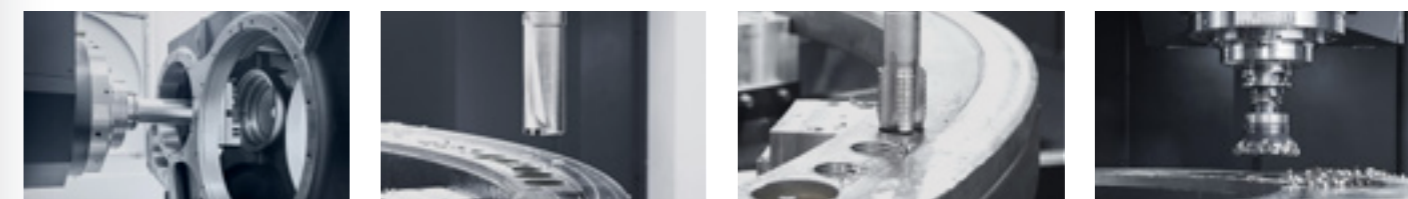

MILLING

VERTICAL DRILLING

VERTICAL TAPPING

MILLING OF NICKEL BASED SUPER ALLOY

BY USING THE STANDARD ELECTROSPINDLE* IN Ck45 STEEL

- Available power: 48 kW**
- Material Removal rate: 1484 cm³ / min
 - Working tool: High feed mill ø66 mm (Z4)
 - Spindle speed: 2115 rpm (Vc= 438 m/min)
 - Working feed: 21.000 mm/min (Fz= 2,48 mm)
 - Depth / Width of cut: ap= 1,5 mm / ae= 47 mm

* High performance Milling

BY USING THE STANDARD ELECTROSPINDLE IN Ck45 STEEL

- Available power: 25 kW**
- Material Removal rate: 560 cm³ / min
 - Working tool: Modular drill ø80 mm
 - Spindle speed: 796 rpm (Vc= 200 m/min)
 - Working feed: 111 mm/min (Fn= 0,14 mm)

BY USING THE STANDARD ELECTROSPINDLE IN Ck45 STEEL

- Available power: 2,7 kW**
- Working tool: Tap M45x4,5
 - Spindle speed: 85 rpm (Vc= 12 m/min)
 - Working feed: 385,5 mm/min (Fn= 4,5 mm)

BY USING THE STANDARD ELECTROSPINDLE IN INCONEL 625

- Available power: 74 kW**
- Material Removal rate: 930 cm³ / min
 - Working tool: Mill ø50 mm (Z6)
 - Spindle speed: 4500 rpm (Vc= 700 m/min)
 - Working feed: 8100 mm/min (Fz= 0,3 mm)
 - Depth / Width of cut: ap= 3 mm / ae= 37 mm

BY USING THE OPTIONAL ELECTROSPINDLE* IN HARDOX 500

- Available power: 18 kW**
- Material Removal rate: 158 cm³ / min
 - Working tool: Long edge square shoulder milling ø80 mm (Z4)
 - Spindle speed: 350 rpm (Vc= 88 m/min)
 - Working feed: 350 mm/min (Fz= 0,25 mm)
 - Depth / Width of cut: ap= 45 mm / ae= 10 mm

* Side Milling

BY USING THE OPTIONAL ELECTROSPINDLE IN HARDOX 500

- Available power: 26 kW**
- Material Removal rate: 560 cm³ / min
 - Working tool: Modular drill ø35 mm
 - Spindle speed: 510 rpm (Vc= 56 m/min)
 - Working feed: 165 mm/min (Fn= 0,33 mm)

BY USING THE OPTIONAL ELECTROSPINDLE 42CrMo4

- Available power: 4,4 kW**
- Working tool: Tap M60x5,5
 - Spindle speed: 40 rpm (Vc= 8 m/min)
 - Working feed: 220 mm/min (Fn= 5,5 mm)

BY USING THE OPTIONAL ELECTROSPINDLE IN INCONEL 625

- Available power: 52 kW**
- Material Removal rate: 930 cm³ / min
 - Working tool: Mill ø50 mm (Z6)
 - Spindle speed: 4500 rpm (Vc= 700 m/min)
 - Working feed: 8100 mm/min (Fz= 0,3 mm)
 - Depth / Width of cut: ap= 3 mm / ae= 37 mm

Subject to change without prior motive. Informative contents are not binding.

- 1_ General view
- 2_ Application industries
- 3_ Advantages
- 4_ Characteristics
- 5_ Machine Configuration
- 6_ The range
- 7_ Technological integration
- 8_ Technical data

8.3_ MACHINE DIMENSIONS

MACHINES EXTERNAL DIMENSIONS

Representative views of standard T12, T16 and T22 models, with access platform and adjacent modules or systems.

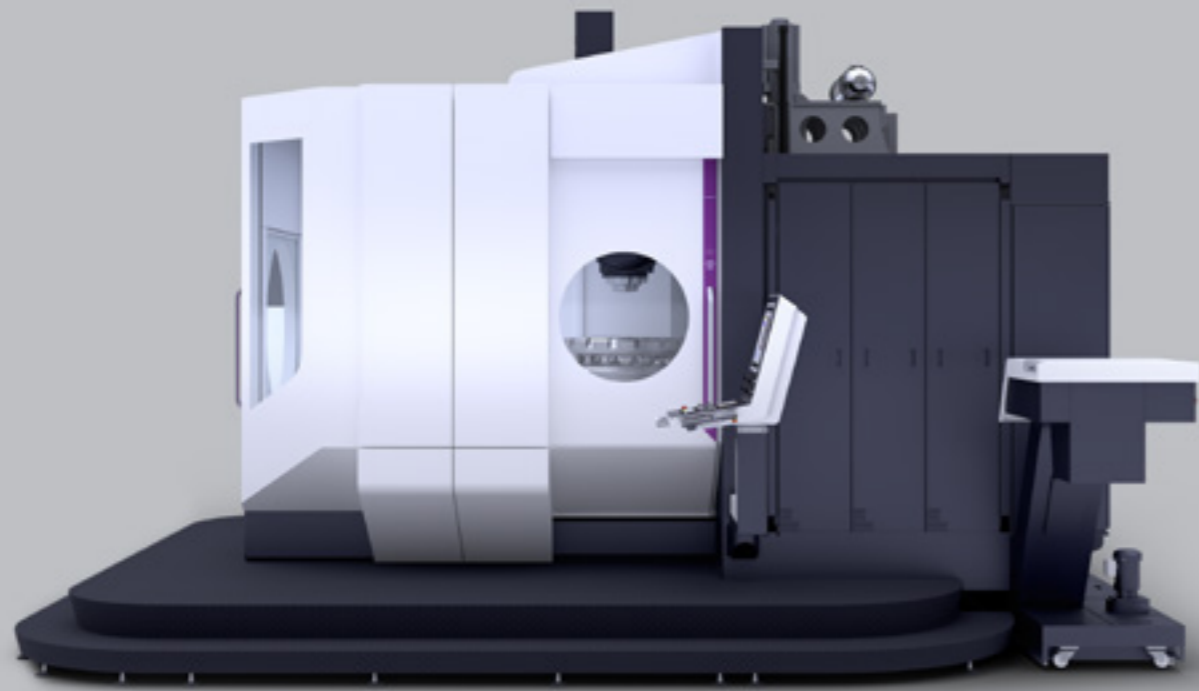

T SERIES

THC/THR 12

THC/THR 16

THC/THR 22

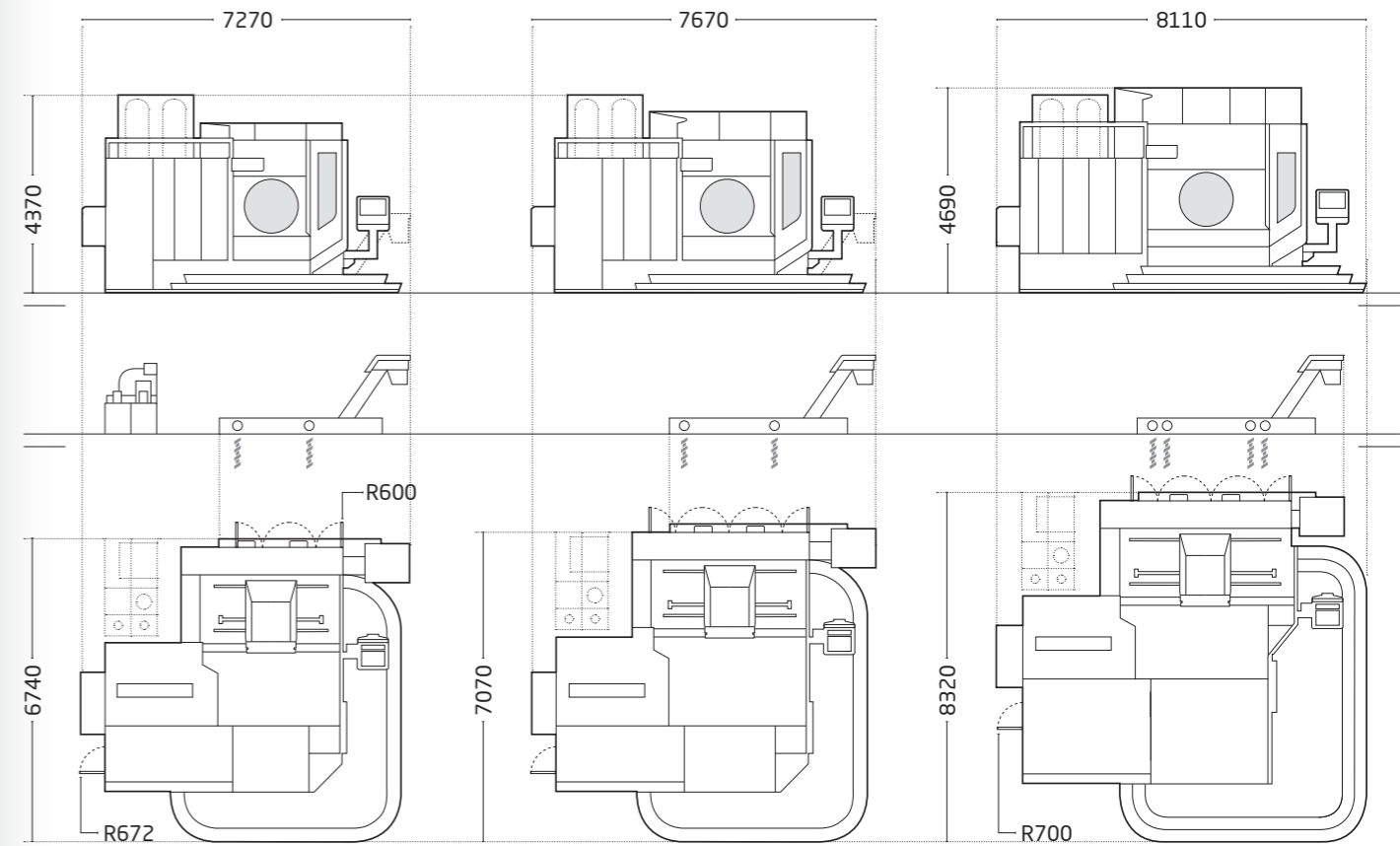

HIGH PRODUCTIVITY OF MEDIUM DIAMETER PARTS

HIGH PRODUCTIVITY OF BIG DIAMETER PARTS

Maximum swing diameter
 ø 1250 mm
 Maximum part height
 h 1600 mm
 Maximum load capacity
 4500 Kg

Maximum swing diameter
 ø 1600 mm
 Maximum part height
 h 1700 mm
 Maximum load capacity
 6000 Kg

Maximum swing diameter
 ø 2200 mm
 Maximum part height
 h 1750 mm
 Maximum load capacity
 10.000 Kg

T MULTIPROCESS TECHNICAL DATA

TRAVELS

	T 36	T 30	T 22	T 16	T 12
-X axis travel (length)	3600 mm	3000 mm	2200 mm	1600 mm	1200 mm
-Y axis travel (cross)	2300 mm	2000 mm	1600 mm	1600 mm	1300 mm
-Z axis travel (vertical)	1900 mm	1700 mm	1500 mm	1200 mm	1000 mm
-B - A axis heads tilting range	B: -15° / +195° - A: -45° / +135°				
-Maximum swing diameter	3600 mm	3000 mm	2200 mm	1600 mm	1250 mm
-Piece maximum height	2150 mm	1950 mm	1750 mm	1700 mm	1600 mm
-Distance spindle nose-table. Vertical (B axis)	100 / 2000 mm	100 / 1800 mm	100 / 1800 mm	100 / 1300 mm	100 / 1100 mm
-Distance spindle nose-table. Horizontal (B axis)	100 / 2000 mm	100 / 1800 mm	100 / 1800 mm	100 / 1300 mm	100 / 1100 mm
-Distance spindle nose-table. Vertical (A axis)	-115 / 1785 mm	-115 / 1585 mm	-115 / 1385 mm	-115 / 1085 mm	-115 / 885 mm
-Distance spindle nose-table. Horizontal (A axis)	260 / 2160 mm	260 / 1960 mm	260 / 1760 mm	260 / 1460 mm	260 / 1260 mm

TABLE*

	ø 2000 mm	ø 1800 mm	ø 1600 mm	ø 1200 mm	ø 1000 mm
-Table dimensions	22.500 - *16.000 kg	20.000 - *14.000 kg	10.000 - *6000 kg	6000 - *3000 kg	4500 - *2250 kg
-Maximum table load capacity (*turning)	90 rpm	88 rpm	189 rpm	258 rpm	300 rpm
-Nominal speed	150 rpm	200 rpm	400 rpm	500 rpm	500 rpm
-Maximum speed	12.000 Nm	10.000 Nm	4000 Nm	3000 Nm	1850 Nm
-Nominal torque					

TILTING HEAD

-Turning torque	1210 Nm
-Position clamping force	7000 Nm

MAIN SPINDLE

-Tool holder	Standard: HSK A 100 - Option: Capto C8
-Maximum speed	Standard: 12.000 rpm - Option: 7000 rpm
-Maximum power	Standard: 84 kW - Option: 75 kW
-Maximum torque	Standard: 452 Nm - Option: 871 Nm

FEED

Maximum working feed X-Y-Z axes	30 m/min	50 m/min	60 m/min		
-Rapid feed for positioning X-Z axes	40 m/min	50 m/min	60 m/min		
-Rapid feed for positioning Y axis	30 m/min	50 m/min	60 m/min		
-X-Y-Z axes acceleration	1,5 / 1,5 / 2 m/s ²	2,5 / 2,3 / 4 m/s ²	2,7 / 3,2 / 4,8 m/s ²	4 / 4 / 5 m/s ²	4 / 5 / 5 m/s ²
-Rapid feed for positioning in B-A axes	50 rpm				

ACCURACY VDI / DGQ3441

	12 µm	10 µm	7 µm	6 µm
-Positioning Tp X-Y-Z (1000 mm)*				
-Repeatability	7 µm		5 µm	
-Measuring system on B - A axes	Rotary scale			
-Positioning accuracy B - A axes	+/- 5 s			
-Positioning accuracy C axis	+/- 4 s			

CAPACITIES

-Milling capacity in steel St 60	1100 cm ³ /min
-Drilling capacity in steel St 60	ø 70 mm
-Tapping capacity in steel St 60	M 45 mm

TOOL MAGAZINE

	Standard: 60. Option: 120, 240, 360				
-Number of tools	600 mm				
-Maximum tool length	30 kg				
-Maximum tool weight	125 mm				
-Maximum tool diameter with full magazine	250 mm				
-Maximum tool diameter with free spaces	6 s				
-Tool changing time*	16 s	14 s	12 s	8 s	7 s
-Chip to chip time					

CNC CONTROL

-Available digital controls	Fanuc / Heidenhain / Siemens
-----------------------------	------------------------------

T EXTREME TECHNICAL DATA

TRAVELS

	T 36	T 30	T 22	T 16	T 12
-X axis travel (length)	3600 mm	3000 mm	2200 mm	1600 mm	1200 mm
-Y axis travel (cross)	2300 mm	2000 mm	1600 mm	1600 mm	1300 mm
-Z axis travel (vertical)	1900 mm	1700 mm	1500 mm	1200 mm	1000 mm
-B - A axis heads tilting range	B: -15° / +195° - A: -45° / +135°				
-Maximum swing diameter	3600 mm	3000 mm	2200 mm	1600 mm	1250 mm
-Piece maximum height	2150 mm	1950 mm	1750 mm	1700 mm	1600 mm
-Distance spindle nose-table. Vertical (B axis)	100 / 2000 mm	100 / 1800 mm	100 / 1800 mm	100 / 1300 mm	100 / 1100 mm
-Distance spindle nose-table. Horizontal (B axis)	100 / 2000 mm	100 / 1800 mm	100 / 1800 mm	100 / 1300 mm	100 / 1100 mm
-Distance spindle nose-table. Vertical (A axis)	-115 / 1785 mm	-115 / 1585 mm	-115 / 1385 mm	-115 / 1085 mm	-115 / 885 mm
-Distance spindle nose-table. Horizontal (A axis)	260 / 2160 mm	260 / 1960 mm	260 / 1760 mm	260 / 1460 mm	260 / 1260 mm

TABLE*

	1600 x 1600 mm	1250 x 1600 mm	1250 x 1250 mm	1000 x 1000 mm	800 x 800 mm
-Table dimensions	25.000 kg	20.000 kg	10.000 kg	3000 kg - Op. 6000 kg	2000 kg - Op. 4000 kg
-Maximum table load capacity	1,5 rpm		30 rpm	35 rpm	
-Nominal speed	5 rpm		40 rpm	50 rpm	
-Maximum speed	18.000 Nm	13.000 Nm	6000 Nm	3100 Nm	2100 Nm
-Nominal torque					

TILTING HEAD

-Turning torque	1210 Nm
-Position clamping force	7000 Nm

MAIN SPINDLE

-Tool holder	Standard: SK 50 - Option: BT 50 / HSK A-100 / Capto C8
-Maximum speed	Standard: 12.000 rpm - Option: 7000 rpm
-Maximum power	Standard: 84 kW - Option: 75 kW
-Maximum torque	Standard: 452 Nm - Option: 871 Nm

FEED

Maximum working feed X-Y-Z axes	30 m/min	50 m/min	60 m/min		
-Rapid feed for positioning X-Z axes	40 m/min	50 m/min	60 m/min		
-Rapid feed for positioning Y axis	30 m/min	50 m/min	60 m/min		
-X-Y-Z axes acceleration	1,5 / 1,5 / 2 m/s ²	2,5 / 2,3 / 4 m/s ²	2,7 / 3,2 / 4,8 m/s ²	4 / 4 / 5 m/s ²	4 / 5 / 5 m/s ²
-Rapid feed for positioning in B-A axes	50 rpm				

ACCURACY VDI / DGQ3441

	12 µm	10 µm	7 µm	6 µm
-Positioning Tp X-Y-Z (1000 mm)*				
-Repeatability	7 µm		5 µm	
-Measuring system on B - A axes	Rotary scale			
-Positioning accuracy B - A axes	+/- 5 s			
-Positioning accuracy C axis	+/- 4 s			

CAPACITIES

-Milling capacity in steel St 60	1100 cm ³ /min
-Drilling capacity in steel St 60	ø 70 mm
-Tapping capacity in steel St 60	M 45 mm

TOOL MAGAZINE

	Standard: 60. Option: 120, 240, 360				
-Number of tools	600 mm				
-Maximum tool length	30 kg				
-Maximum tool weight	125 mm				
-Maximum tool diameter with full magazine	250 mm				
-Maximum tool diameter with free spaces	6 s				
-Tool changing time*	16 s	14 s	12 s	8 s	7 s
-Chip to chip time					

CNC CONTROL

-Available digital controls	Fanuc / Heidenhain / Siemens
-----------------------------	------------------------------



IBARMIA SERVICE

YOUR SERVICE POINT

When a customer becomes part of the IBARMIA family, that special link makes us work together throughout the machine's lifetime. Our service-point guides all technical and human resources to satisfy the customer's needs from the moment the machine enters its facilities.

WE BELIEVE IN SERVICE AND WE ARE COMMITTED TO THE PROFITABILITY AND RELIABILITY OF YOUR MACHINE; A PROVEN EFFICIENT SERVICE THAT IS VALUED BY OUR CUSTOMERS.



TELEPHONE SUPPORT SERVICE BY EXPERT MULTILINGUAL STAFF



REACTION AND SOLUTION TIMES ADEQUATE TO THE CUSTOMER'S NEEDS



HIGHLY QUALIFIED TECHNICIANS



GLOBAL SERVICE VOCATION



MACHINE RECALIBRATION

The accumulation of working hours and other factors might affect the machine's adjustment. At servicepoint we offer the possibility of readjusting the machines, leaving them almost as brand new.

PERIODIC PREVENTION MAINTENANCE

Servicepoint staff regularly checks and tunes up the machine, ensuring optimum machine availability.

CRITICAL COMPONENTS HIRE

Our machines have a high level of technology reflected on key elements of high value, and sometimes long delivery times. Following our commitment to reduce the machine break down times to a minimum, we stock those key elements for hire.

CUSTOMIZED MAINTENANCE CONTRACTS

Various levels of maintenance contracts adjustable to each customer.

SPARE PART MANAGEMENT

We are well aware of the importance of ensuring that the parts replaced in our machines maintain the same quality as the originals. Our spare part management service takes care of this.

ASSISTANCE AND LOCAL SERVICE

Our objective is to respond to our customers quickly, efficiently and at a reasonable cost. We are creating a global service network to ensure we respond to our clients in the shortest possible time.

REMOTE AND ONLINE MONITORING AND DIAGNOSE

It allows knowing the machine status from the distance to ensure an intelligent diagnose of the key elements.



IBARMIA SERVICE



ADVANCED DATA MANAGEMENT: ONLINE MONITORING AND DIAGNOSIS



SMART POINT SOFTWARE

Thanks to our SMART POINT cloud monitoring system, we have real-time information about the status of your machine, and we are able to make an intelligent diagnosis of the critical components. SMART POINT allows us to record and process the data collected on your machine, thus generating valuable information about the optimal use, the life cycle of the parts or the manufacturing process itself.

- Monitor your machines activity in real time from anywhere in the world
- Anticipate machine breakdowns and maximize its availability. Discover the root of the errors so you can correct them, as well as consumable exchange dates and component health status.





IBARMIA.

IBARMIA

GOING BIGGER, GETTING CLOSER

The last few years at IBARMIA have been intense in growth for the company. Determined to stay close to customers, the company has kept deepening the roots in the biggest markets of the world. This tendency will be kept in the future, with further development of these two areas of the world and others to come.

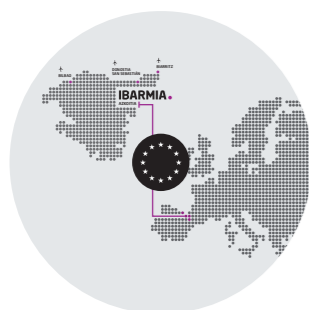
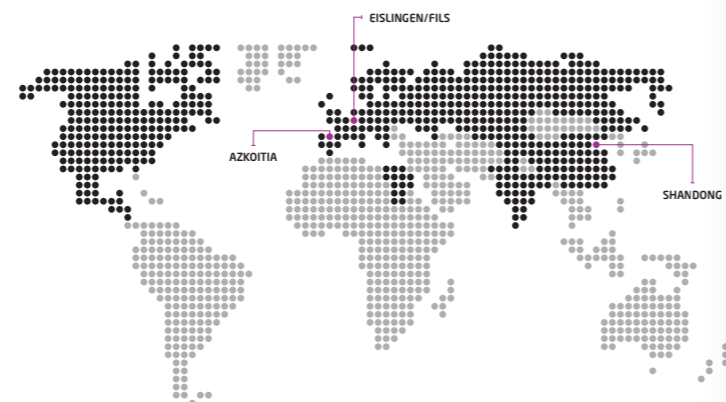

IBARMIA Azkoitia
PRODUCTION CENTER
(Gipuzkoa) Spain

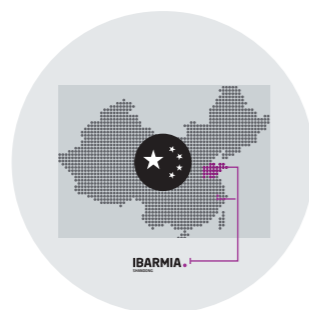

IBARMIA Qingdao
PRODUCTION CENTER
IBARMIA Shanghai
SALES OFFICE
(Shandong-Shanghai) P.R. of China



IBARMIA Eislingen/Fils
SALES & SERVICE OFFICE
(Baden-Württemberg) Germany

70 IBARMIA.
YEARS
EST. 1953



COMPETING IN THE
GLOBAL MARKET



A YOUNG TEAM WITH
HIGH FORMATION



INTEGRATED
MANUFACTURING



TOTAL
FLEXIBILITY

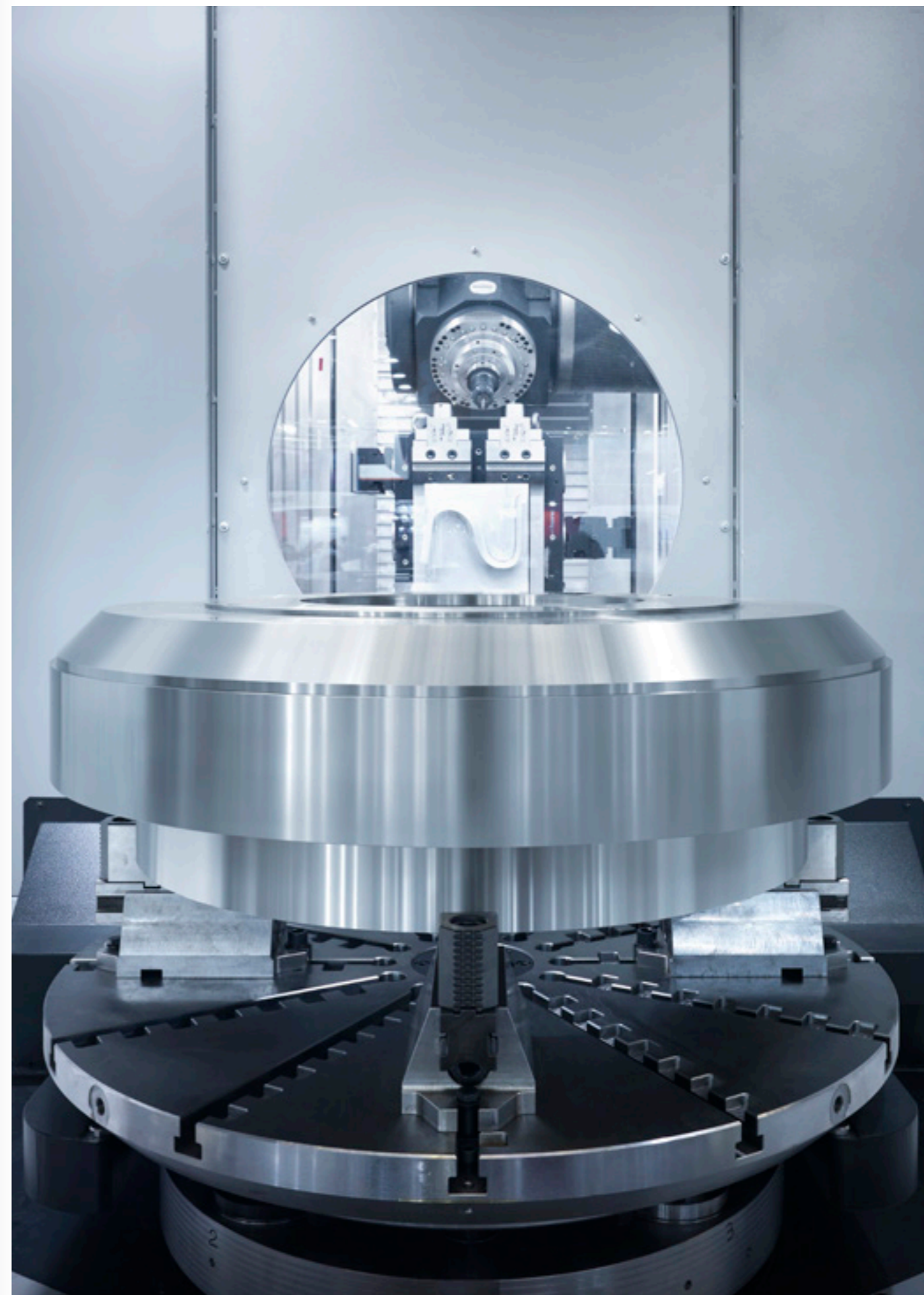

YOUR MACHINE TOOL POINT

EST. 1953

T SERIES
5 AXIS UNIVERSAL
MACHINING
CENTERS

STG 06/23
Subject to changes
without previous warning.
Informative content
is not binding.

IBARMIA is an advanced technology manufacturer of
high added-value solutions adapted to customers' needs
by highly customized machining centers.



Diego Umantsoro, 5 - Apdo 35
20720 Azkoitia (Gipuzkoa) Spain. T +34 943 857 000
ibarmia@ibarmia.com

Follow us on our social networks



www.ibarmia.com
